







80%

## OVER 80% OF THE FASTENERS WE SELL ARE MANUFACTURED IN CINCINNATI

- Steel rod purchased from US manufacturers
- Rod drawn down to exact wire gauge sizes
- ICC Certified Facility
- Clean wire process
- Each box date stamped for Quality Assurance
- All precision forming dies made in house



# TABLE OF CONTENTS

See all tools at a glance in the foldout located on pages 88-90

## DuraSpin Auto-Feed Screw Systems



DS225-18V, DS222-18V, DS322-18V	3
DS245-AC, DS242-AC, DS342-AC	4
DS230-S1, DS230-M1, DS230-D1, DS230-D2	5
DS530 Series, DS532-AC, DS534-AC	6
SG2510, SG4100	7
Collated Screws	8-11
Screw System Accessories	12-13

## Finish & Woodworking



F-18XP, F-16XP, F-15XP, F-LXP	15
TN11G1, TN11L1	16
TN21L1, LS1XP, FinishPro18Mg, FinishPro18BMg	17
SLP20XP, FinishPro25XP, FinishPro16XP	18
FinishPro30XP, FinishPro35Mg, FinishPro42XP	19
SLS20XP, SLS25XP, SKSXP	20
SLS150Mg, SLS18Mg	21
SC1XP Senclamp, SC2 Sencor	22
Fasteners	23-29

## Framing, Sheathing & Subfloors



F-35XP, F-35FRHXP	31
FN91T, FN81T1	32
FramePro325XP, FramePro701XP, FramePro751XP	33
FramePro325FRHXP, FramePro702XP, FramePro752XP	34
SCN60XP, SCN65XP, Mini Hand Nailer, A20 Hand Nailer	35
JN91H1, JN91H2, JN91P1, JN91P2	36
SCP40XP, PS15XP, PS20XP	37
NS20XP, NS20BXP, SNS41, SQS55XP	38
Fasteners	39-47

## Roofing, Siding & Fencing



RoofPro445XP, SN71P1	49
PS15RXP, BC58, A11	50
Fasteners	51-53

## Pallets & Crating



PalletPro57FXP, PalletPro100XP, PalletPro130XP	55
DFPXP, F75LXP, F75SXP	56
Fasteners	57-59

## Upholstery & Furniture



SFT10XP Family	61
SFW09, NS20BXP	62
Fasteners	63-65

## Flooring



SFH200, SLS20XP-HF	67
Fasteners	68

## Air Compressors



PC1131, PC0968, PC1280, PC1010, PC1010N, PC0947	71
---	----

## Accessories



Air Hoses	73
Plugs & Couplers, Swivel Plugs & Swivel Couplers	74
Air Hose & Compressor Accessories, Regulators & Gauges	75
Oils & Lubricants, Safety Glasses & Tool Belt Hooks	76
Battery & Charger Systems, No-Mar Pads	77
Parts Kits	78

## Product Reference



Fastener Finish Types	79
Box, Carton & Pallet Quantities - Fasteners	80-81
Item Code Index	82-85
Fasteners at a Glance	86-87
Tools at a Glance	88-90



# DURASPIN AUTO-FEED SCREW SYSTEMS

## **DURASPIN™** **PRODUCTIVITY REDEFINED**

DuraSpin® screw systems help you get the job done up to four times faster than bulk screwdrivers and loose screws, improving jobsite productivity by more than 30%.

### **APPLICATIONS**

Our full line of integrated tools, attachments, kits, and accessories can tackle almost any job including drywall, sub-flooring, decking, metal framing, and a variety of commercial and industrial applications. For projects with tough requirements, our wide selection of ICC and Miami-Dade certified screws will keep your job on target. Check out our next generation of DuraSpin® auto-feed screw systems with enhanced features that redefine productivity and help you get the job done faster and easier.

### **KEY FEATURES**

- Patented corner-fit feed system for better screw placement in tight spaces and corners
- Locking depth-of-drive adjustment
- Tool-free adjustable nosepiece
- Easily load 50 screws in less than a second
- Trigger lock for continuous operation
- Long-lasting drive bits with quick-slide release





## DS225-18V

2" CORDLESS 18V LI-ION 5000 RPM

ITEM #10A0001N



5000  
RPM/TPM

BRUSHLESS  
MOTOR

2 bits included



### Features

- High-speed, efficient brushless motor designed for drywall applications
- Features feed on return - the next screw is aligned with the bit for better line of sight and more accurate screw placement
- Patented corner fit technology
- Includes 2 bits, 2 extended life batteries, quick charge battery charger and storage bag

### PRIMARY APPLICATIONS

High Speed Applications Including Drywall to Wood or Light Steel

### SECONDARY APPLICATIONS

Subfloor, Sheathing, Cement Board, Underlayment

## DS222-18V

2" CORDLESS 18V LI-ION 2500 RPM

ITEM #10B0001N



2500  
RPM/TPM

BRUSHLESS  
MOTOR

2 bits included



### Features

- Selectable 2500/1600 RPM efficient brushless motor
- Features feed on return - the next screw is aligned with the bit for better line of sight and more accurate screw placement
- Patented corner fit technology
- Includes 2 bits, 2 extended life batteries, quick charge battery charger and storage bag

### PRIMARY APPLICATIONS

High Torque Applications Including Metal Framing/Decking

### SECONDARY APPLICATIONS

Crating, Gypsum/Sheathing to Steel, Decking, Subfloor

## DS322-18V

3" CORDLESS 18V LI-ION 2500 RPM

ITEM #10C0001N



2500  
RPM/TPM

BRUSHLESS  
MOTOR

2 bits included



### Features

- Selectable 2500/1600 RPM efficient brushless motor
- Toe nailing nosepiece
- Variable speed selector for heavy steel
- Features feed on return - the next screw is aligned with the bit for better line of sight and more accurate screw placement
- Includes 2 bits, 2 extended life batteries, quick charge battery charger and storage bag

### PRIMARY APPLICATIONS

General Applications Including Wood Decking, Tile Roofing, Crating

### SECONDARY APPLICATIONS

Decking, Docks, Crating, Gypsum/Sheathing to Steel, Tile Roofing

## DURASPIN™ Auto-Feed Cordless Screwdrivers

### Productivity Redefined

- Patented corner-fit feed system
- Detachable feed system to expose bit for quick reversing
- Precise depth of drive adjustment with depth lock
- Quick slide button bit change
- Universal toe-nailing nosepiece
- Powered by 18V Li-Ion extended life batteries
- Quick charge battery charger
- Tool-free screw length adjustment
- Variable speed trigger with lock and reverse
- Adjustable belt hook



## Product Reference Chart

TOOL SPECS	DS225-18V	DS222-18V	DS322-18V
<b>Speed (RPM)</b>	0-5000	0-1600, 0-2500 (Selectable)	0-1600, 0-2500 (Selectable)
<b>Voltage</b>	18V	18V	18V
<b>Weight w/ Battery</b>	5.1 lbs (2.3 kg)	5.3 lbs (2.4 kg)	5.4 lbs (2.5 kg)
<b>Height</b>	9.6" (244 mm)	9.6" (244 mm)	9.6" (244 mm)
<b>Length</b>	13.7" (348 mm)	13.7" (348 mm)	14.5" (368 mm)
<b>Width</b>	3.4" (86.4 mm)	3.4" (86.4 mm)	3.4" (86.4 mm)
<b>Warranty</b>	5 yr	5 yr	5 yr
<b>FASTENER SPECS</b>	Collated screws are located on pages 8-11		
<b>Range</b>	1"-2"*	1"-2"*	1"-3"
<b>Shank Diameter</b>	#6 - #8	#6 - #12	#6 - #12
<b>TOOL FEATURES</b>			
<b>Depth-of-Drive</b>	Yes	Yes	Yes
<b>Reversible Belt Hook</b>	Yes	Yes	Yes
<b>Trigger</b>	Variable with Lock	Variable with Lock	Variable with Lock
<b>Power Type</b>	Cordless	Cordless	Cordless
<b>Reversible</b>	Yes	Yes	Yes

\* 1/2" - 2" with nosepiece sold separately, part #FC0822



## DS245-AC

2" CORDED 5000 RPM

ITEM #10D0001N



5000  
RPM/TPM

2 bits included



### Features

- High-speed motor designed for drywall applications
- Corner-fit feed system
- Feed on return
- Includes 2 bits and carrying bag

### PRIMARY APPLICATIONS

Drywall to Wood, Drywall to Light Steel, Underlayment, Cement Board

### SECONDARY APPLICATIONS

Subfloor, Wood Decking

## DS242-AC

2" CORDED 2500 RPM

ITEM #10E0001N



2500  
RPM/TPM

2 bits included



### Features

- High-torque motor for driving into dense material
- Corner-fit feed system
- Feed on return
- Includes 2 bits and carrying bag

### PRIMARY APPLICATIONS

Metal Framing, Cement Board

### SECONDARY APPLICATIONS

Drywall to Wood, Drywall to Steel, Subfloor, Underlayment, Wood Decking, Composite Decking

## DS342-AC

3" CORDED 2500 RPM

ITEM #10F0001N



2500  
RPM/TPM

2 bits included



### Features

- High-torque motor for driving into dense material
- Corner-fit feed system
- Feed on return
- Includes 2 bits and carrying bag

### PRIMARY APPLICATIONS

Wood Decking, Composite Decking, Sheathing to Steel

### SECONDARY APPLICATIONS

Drywall to Wood, Drywall to Steel, Subfloor, Underlayment, Metal Framing, Cement Board

## DURASPIN™ Auto-Feed Coded Screwdrivers

### Productivity Redefined

- Patented corner-fit feed system
- Precise depth of drive adjustment with depth lock
- Quick slide button bit change
- Universal toe-nailing nosepiece
- Tool-free screw length adjustment
- Variable speed trigger with lock and reverse
- Screw-strip guide
- Adjustable belt hook
- Heavy duty 10' power cord



## Product Reference Chart

TOOL SPECS	DS245-AC	DS242-AC	DS342-AC
<b>Speed (RPM)</b>	0-5000	0-2500	0-2500
<b>Current (Amps)</b>	6.0	6.0	6.0
<b>Voltage</b>	120V/60Hz	120V/60Hz	120V/60Hz
<b>Weight</b>	5.5 lbs (2.5 kg)	5.7 lbs (2.6 kg)	6.7 lbs (3.0 kg)
<b>Height</b>	9.7" (246 mm)	9.7" (246 mm)	9.7" (246 mm)
<b>Length</b>	16.3" (417 mm)	16.4" (417 mm)	17.2" (437 mm)
<b>Width</b>	3.2" (81 mm)	3.2" (81 mm)	3.2" (81 mm)
<b>Warranty</b>	5 yr	5 yr	5 yr
FASTENER SPECS	Collated screws are located on pages 8-11		
<b>Range</b>	1"-2"*	1"-2"*	1"-3"
<b>Shank Diameter</b>	#6 - #10	#6 - #12	#6 - #12
TOOL FEATURES			
<b>Depth-of-Drive</b>	Yes	Yes	Yes
<b>Reversible Belt Hook</b>	Yes	Yes	Yes
<b>Trigger</b>	Variable with Lock	Variable with Lock	Variable with Lock
<b>Power Type</b>	Corded	Corded	Corded
<b>Reversible</b>	Yes	Yes	Yes

\* 1/2" - 2" with nosepiece sold separately, part #FC0822



## DS230-S1

2" AUTO-FEED SCREWDRIVER ATTACHMENT

ITEM # #9Z0001N

2 bits included



COMPATIBLE WITH:  
**SENCO®**  
SELECT MODELS

For SENC0 Models:

- SG2510
- SG4100

### PRIMARY APPLICATIONS

Drywall (Into Wood or Steel Studs)

### SECONDARY APPLICATIONS

Metal Framing, Sheathing, Cement Board

## DS230-M1

2" AUTO-FEED SCREWDRIVER ATTACHMENT

ITEM #9Z0021N

2 bits included



COMPATIBLE WITH:  
**MAKITA®**  
SELECT MODELS

For MAKITA Models:

- FS2200
- FS2500
- FS4200
- FS6200
- XSF03
- XSF04
- XSF05

### PRIMARY APPLICATIONS

Drywall (Into Wood or Steel Studs)

### SECONDARY APPLICATIONS

Metal Framing, Sheathing, Cement Board

## DS230-D1

2" AUTO-FEED SCREWDRIVER ATTACHMENT\*

ITEM #9Z0011N

2 bits included



COMPATIBLE WITH:  
**DeWALT®**  
SELECT MODELS

\*Includes Adaptor

For DeWALT Models (Corded):

- DW252
- DW253
- DW255
- DW257
- DW266
- DW272
- DW276

### PRIMARY APPLICATIONS

Drywall (Into Wood or Steel Studs)

### SECONDARY APPLICATIONS

Metal Framing, Sheathing, Cement Board

## DS230-D2

2" AUTO-FEED SCREWDRIVER ATTACHMENT

ITEM #9Z0012N

2 bits included



COMPATIBLE WITH:  
**DeWALT®**  
SELECT MODELS

For DeWALT Models (Cordless):

- DCF620

### PRIMARY APPLICATIONS

Drywall (Into Wood or Steel Studs)

### SECONDARY APPLICATIONS

Metal Framing, Sheathing, Cement Board

## DURASPIN™ 2" Auto-Feed Screwdriver Attachments

Convert a standard screwdriver into an auto-feed screw system in seconds

- Patented corner-fit feed system
- Feed on return functionality to improve speed and reliability of drives
- Universal nosepiece for drywall and wood applications
- Easily remove attachment to access bit
- Tool-free screw length adjustment
- Supports several screwdriver models
- Precise depth of drive adjustment with depth lock



## Product Reference Chart

TOOL SPECS	DS230-S1	DS230-M1	DS230-D1	DS230-D2
<b>Weight</b>	1.3 lbs (.59 kg)	1.3 lbs (.59 kg)	1.3 lbs (.59 kg)	1.3 lbs (.59 kg)
<b>Height</b>	5.5" (140 mm)	5.5" (140 mm)	5.5" (140 mm)	5.5" (140 mm)
<b>Length</b>	11.0" (280 mm)	11.0" (280 mm)	10.8" (274 mm)	10.3" (262 mm)
<b>Width</b>	2.5" (64 mm)	2.5" (64 mm)	2.5" (64 mm)	2.5" (64 mm)
<b>Warranty</b>	5 yr	5 yr	5 yr	5 yr
<b>FASTENER SPECS</b>	Collated screws are located on pages 8-11			
<b>Range</b>	1"-2"	1"-2"	1"-2"	1"-2"
<b>Shank Diameter</b>	#6 - #12	#6 - #12	#6 - #12	#6 - #12
<b>TOOL FEATURES</b>				
<b>Depth-of-Drive</b>	Yes	Yes	Yes	Yes





## DS530 Series

3" AUTO-FEED SCREWDRIVER ATTACHMENT

ITEM #10X0002N | #10X0012N | #10X0022N



### Features

- Feed On Return
- Patented Sliding Screw Guide
- Corner-Fit Feed System
- Quick Release Clamp
- Extension Pole
- Adjustable Depth-of-Drive with Depth Lock

### APPLICATIONS

Sheathing, decking, underlayment, sub-flooring, steel decking, drywall, cement board, rigid foam insulation

**DS530-S1 (10X0002N)**  
for SENC0 Models:

- SG2510 • SG4100

**DS530-D1 (10X0012N)**  
for DeWalt Models:

- DW252 • DW253 • DW255
- DW257 • DW266 • DW272
- DW276 • DCF624

**DS530-M1 (10X0022N)**  
for MAKITA Models:

- FS2200 • FS2500 • FS4200
- FS6200 • XSF03 • XSF04
- XSF05

## DS532-AC

3" ATTACHMENT KIT WITH 2500 RPM SCREWDRIVER

ITEM #10X0003N

**2500**  
RPM/TPM



3 bits included



### Features

- 3-in-1 Tool Kit
- Feed On Return
- Patented Sliding Screw Guide
- Corner-Fit Feed System
- Quick Release Clamp

### APPLICATIONS

Wood and Composite Decking, Cement Board, Sub-Flooring and Underlayment, Sheathing to Steel, Steel Decking, Drywall to Wood or Steel

## DS534-AC

3" ATTACHMENT KIT WITH 4000 RPM SCREWDRIVER

ITEM #10X0013N

**4000**  
RPM/TPM



3 bits included



### Features

- 3-in-1 Tool Kit
- Feed On Return
- Patented Sliding Screw Guide
- Corner-Fit Feed System
- Quick Release Clamp

### APPLICATIONS

Sub-Flooring, Underlayment, Wood and Composite Decking, Cement Board, Drywall to Wood, Drywall to Steel

## Product Reference Chart

TOOL SPECS	DS530 SERIES
<b>Weight</b>	3.4 lbs. (1.5 kg)
<b>Height</b>	3.5" (89 mm)
<b>Length</b>	33" (838 mm)
<b>Width</b>	2.75" (70 mm)
<b>Warranty</b>	5 yr
<b>FASTENER SPECS</b>	Collated screws are located on pages 8-11
<b>Range</b>	1"-3"
<b>Shank Diameter</b>	#6 - #12
<b>TOOL FEATURES</b>	
<b>Depth-of-Drive</b>	Yes

Additional screwdrivers, bits and adaptors sold separately — see page 12

## Product Reference Chart

TOOL SPECS	DS532-AC	DS534-AC
<b>Speed (RPM)</b>	0-2500	0-4000
<b>Current (Amps)</b>	6.5	6.5
<b>Weight</b>	7 lbs. (3.2 kg)	7 lbs. (3.2 kg)
<b>Height</b>	7" (178 mm)	7" (178 mm)
<b>Length</b>	40.5" (1029 mm)	40.5" (1029 mm)
<b>Width</b>	2.75" (70 mm)	2.75" (70 mm)
<b>Warranty</b>	5 yr	5 yr
<b>FASTENER SPECS</b>	Collated screws are located on pages 8-11	
<b>Range</b>	1"-3"	1"-3"
<b>Shank Diameter</b>	#6 - #12	#6 - #12
<b>TOOL FEATURES</b>		
<b>Depth-of-Drive</b>	Yes	Yes
<b>Belt Hook</b>	Yes	Yes
<b>Trigger</b>	Variable with lock	Variable with lock
<b>Power Type</b>	Corded	Corded
<b>Reversible</b>	Yes	Yes

## SG2510

HIGH-PERFORMANCE 2500 RPM SCREWDRIVER

ITEM #6X0002N

2500  
RPM/TPM



2 bits included



### Features

- High-torque motor for driving into dense materials
- Industrial-grade metal gear housing designed to sustain heavy usage
- Great for all-day use with ergonomic, lightweight and compact design
- Trigger lock for continuous operation
- Industrial-grade 10' cord
- Includes 2 bits (as shown)

### PRIMARY APPLICATIONS

Composite Decking, Wood Decking, Cement Board, Sheathing to Steel, Metal Framing

### SECONDARY APPLICATIONS

Drywall to Wood, Drywall to Steel, Subfloor, Underlayment

## SG4100

HIGH-PERFORMANCE 4000 RPM SCREWDRIVER

ITEM #6X0004N

4000  
RPM/TPM



2 bits included



### Features

- High-speed motor designed for drywall applications
- Industrial-grade metal gear housing designed to sustain heavy usage
- Great for all-day use with ergonomic, lightweight and compact design
- Trigger lock for continuous operation
- Industrial-grade 10' cord
- Includes 2 bits (as shown)

### PRIMARY APPLICATIONS

Drywall to Wood, Drywall to Steel, Subfloor, Underlayment, Cement Board

### SECONDARY APPLICATIONS

Wood Decking

## Nosepieces and drive bits for every application:

drywall, wood, metal and metal channel.







## Product Reference Chart

TOOL SPECS	SG2510	SG4100
<b>Speed (RPM)</b>	0-2500	0-4000
<b>Current (Amps)</b>	6.5	6.5
<b>Weight</b>	3.6 lbs (1.6 kg)	3.4 lbs (1.5 kg)
<b>Height</b>	7.5" (191 mm)	7.5" (191 mm)
<b>Length</b>	12.5" (318 mm)	12" (305 mm)
<b>Width</b>	2.5" (64 mm)	2.5" (64 mm)
<b>Warranty</b>	5 yr	5 yr
TOOL FEATURES		
<b>Depth-of-Drive</b>	Yes	Yes
<b>Belt Hook</b>	Yes	Yes
<b>Trigger</b>	Variable with Lock	Variable with Lock
<b>Power Type</b>	Corded	Corded
<b>Reversible</b>	Yes	Yes

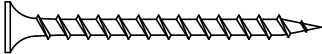

## Drywall to Wood Screws



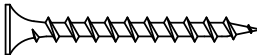

Sharp point drywall screws for fastening interior drywall to wood

Finish: Gray Phosphate				
		 #2 Phillips	 Bugle	 Sharp
Gauge	Length	Thread	Quantity	Item Code
6	1¼"	Coarse	1000 Tub	06A125P
6	1¼"	Coarse	4000 Box	06A125PB
6	1½"	Coarse	1000 Tub	06A162P
6	1½"	Coarse	4000 Box	06A162PB
7	2"	Coarse	1000 Tub	07A200P
8	2½"	Coarse	1000 Box	08A250PK

Finish: Exterior				
Gauge	Length	Thread	Quantity	Item Code
6	1½"	Coarse	1000 Tub	06A162W

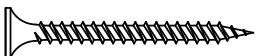



## Drywall to Light Steel Screws



Sharp point, double thread drywall screws for fastening interior drywall to light-gauge metal studs



Finish: Gray Phosphate					
		 #2 Phillips	 Bugle	 Sharp	
Gauge	Length	Thread	Quantity	Item Code	
6	1¼"	Double Thread	1000 Tub	06B125P*	
6	1¼"	Double Thread	4000 Box	06B125PB*	
6	1½"	Double Thread	1000 Tub	06B162P*	
6	1½"	Double Thread	4000 Box	06B162PB*	
6	2"	Double Thread	4000 Box	06B200PB*	

## Gypsum to Heavy Steel Screws

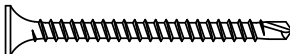
Drywall screws with self-drilling point for fastening drywall or gypsum sheathing to heavy-gauge metal studs

Finish: Clear Zinc					
		 #2 Phillips	 Bugle	 Drill	
Gauge	Length	Thread	Quantity	Item Code	
6	1¼"	Fine	4000 Box	06C125CB*	
6	1½"	Fine	4000 Box	06C162CB*	
6	2"	Fine	4000 Box	06C200CB*	

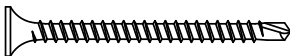



Finish: Exterior					
Gauge	Length	Thread	Quantity	Item Code	
6	1¼"	Fine	1000 Box	06C125WK*	
6	1½"	Fine	1000 Box	06C162WK*	
8	3"	½ Fine	1000 Box	08C300WK	



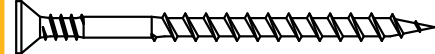

Finish: Gray Phosphate					
Gauge	Length	Thread	Quantity	Item Code	
6	1¼"	Fine	4000 Box	06C125PB*	
6	1½"	Fine	4000 Box	06C162PB*	
6	2"	Fine	4000 Box	06C200PB*	



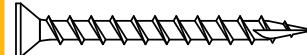

 \*ICC certified test data available on all highlighted items. Refer to ESR-4826 for details.

## Wood to Wood Screws



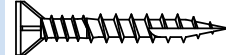

General purpose interior wood screws

Finish: Yellow Zinc				
		 #2 Square	 Flat	 Sharp
Gauge	Length	Thread	Quantity	Item Code
8	1½"	Coarse	1000 Tub	08F150Y
8	1¾"	¾ Coarse	1000 Tub	08F175Y
8	2"	¾ Coarse	1000 Tub	08F200Y
8	2½"	¾ Coarse	800 Tub	08F250Y
8	2½"	¾ Coarse	1000 Box	08F250YK
8	3"	¾ Coarse	800 Tub	08F300Y





Finish: Yellow Zinc				
		 #2 Square	 Flat	 Type 17
Gauge	Length	Thread	Quantity	Item Code
8	1¼"	Coarse	4000 Box	08L175YB

Finish: Clear Zinc				
		 #2 Square	 Flat Head + Nibs	 Type 17
Gauge	Length	Thread	Quantity	Item Code
8	1¼"	Coarse	4000 Box	08L125CBLCTS

Interior wood screws for harder-engineered lumber and flooring materials

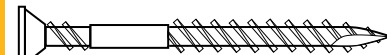
Finish: Yellow Zinc				
		 #2 Square	 Trim Head + Nibs	 Sharp
Gauge	Length	Thread	Quantity	Item Code
8	2"	High Low	4000 Box	08F200YBTHSS

General purpose interior wood screws and subfloors

Finish: Yellow Zinc				
		 Rex	 Flat	 Type 17
Gauge	Length	Thread	Quantity	Item Code
8	1½"	Double	1000 Box	08F150YTK
8	1¾"	2/3 Double	1000 Box	08F175YTK
8	2"	2/3 Double	1000 Box	08F200YTK

# 08F175YTK Double Thread Subfloor Screw



- Type 17 point and double thread design reduces installation time while improving holding power
- Our Rex drive provides smooth engagement with high torque transmitting capability
- Flathead for stronger holding power

# COLLATED SCREWS

## Wood to Heavy Steel Screws

**Pilot point screws for fastening sheathing to heavy steel**

Finish: Clear Zinc



#2 Square Flat Pilot

Gauge	Length	Thread	Quantity	Item Code
8	2"	Fine	1000 Box	08G200CKLFPS*

**Wing drill point screws for fastening sheathing to heavy steel**

Finish: Clear Zinc



#2 Square Wafer + Nibs Wing Drill

Gauge	Length	Thread	Quantity	Item Code
8	1 1/2"	Fine	1000 Tub	08G162CTWFWFS*
10	1 1/2"	Fine	1000 Box	10G162CTWFWFS*

Finish: Exterior



Gauge	Length	Thread	Quantity	Item Code
#8	2"	Fine	1000 Tub	08G200WTWFWFS*
#8	2 1/2"	Fine	1000 Tub	08G250WWK*

**Low profile screw head for fastening sheathing to steel**

Finish: Clear Zinc



#2 Square Wafer Drill

Gauge	Length	Thread	Quantity	Item Code
8	1"	Fine	4000 Box	08G100CBWFDS
10	1 1/2"	Fine	4000 Box	10G125CBWFDS

**Wing drill point screws for fastening sheathing to heavy steel structures**

Finish: Yellow Zinc



Rex Flat Wing T3 Drill

Gauge	Length	Thread	Quantity	Item Code
12	1 3/4"	Fine	1000 Box	12G175YKLFAX*

**Wing drill point screws for fastening sheathing to heavy steel structures**

Finish: Yellow Zinc



Rex Flat Wing T5 Drill

Gauge	Length	Thread	Quantity	Item Code
12	2"	Fine	1000 Box	12G200YKLFXC*
12	2 1/2"	Fine	1000 Box	12G250YKLFXC*



## 08G250WWK Wing drill point screw

- Finish exceeds 1000 hours salt spray testing per ASTM B117

## Wood to Light Steel Screws

**Sharp point screws for fastening sheathing to light steel**

Finish: Clear Zinc



#2 Square Flat Sharp

Gauge	Length	Thread	Quantity	Item Code
8	1 1/2"	Double	1000 Tub	08G150CTLDSS

**Cement Board Screws**

**Screws for fastening cement board or Hardie® board to wood**

Finish: Exterior



#2 Square Wafer + Nibs Spoon

Gauge	Length	Thread	Quantity	Item Code
8	1 1/2"	High Low	1000 Tub	08T125W
8	2"	High Low	1000 Tub	08T200W

**Screws for fastening cement board or Hardie® board to steel studs**

Finish: Exterior



#2 Square Wafer + Nibs Drill

Gauge	Length	Thread	Quantity	Item Code
8	1 1/2"	Fine	4000 Box	08T150WBWFD5

**Decking and Dock Screws**

**Exterior wood screws for projects such as decks, tile roofing, fencing, siding and docks**

Finish: Exterior

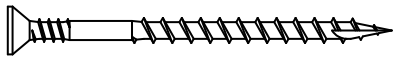

#2 Square Flat Type 17

Gauge	Length	Thread	Quantity	Item Code
8	1 1/2"	3/8 Coarse	1000 Tub	08D175W
8	2"	3/8 Coarse	1000 Tub	08D200W**
8	2 1/2"	3/8 Coarse	800 Tub	08D250W**
8	2 1/2"	3/8 Coarse	1000 Box	08D250WK**
8	3"	3/8 Coarse	800 Tub	08D300W**
8	3"	3/8 Coarse	1000 Box	08D300WK**

Finish: Stainless 304



Gauge	Length	Thread	Quantity	Item Code
8	2 1/2"	3/8 Coarse	800 Tub	08D250S
9	3"	3/8 Coarse	800 Tub	09D300S

**Underlayment Wood to Wood Screws**

Finish: Gray Phosphate



#2 Phillips Trim Head + Nibs Sharp

Gauge	Length	Thread	Quantity	Item Code
7	1"	High Low	4000 Box	07Q100PB

Gray Phosphate		#2 Square		
7	1 1/4"	High Low	4000 Box	07Q125PBQ







\*\* Approved for use in Miami-Dade County FL.



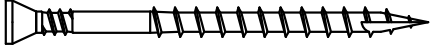



## Composite Decking Screws

Trim head screws for fastening composite decking to wood

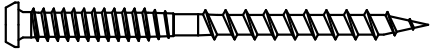
Finish: Exterior					 #2 Square  Trim  Type 17
Gauge	Length	Thread	Quantity	Item Code	
8	2½"	¾ Coarse	800 Tub	08R250W	
8	3"	¾ Coarse	800 Tub	08R300W	

Specially designed cup head screws eliminate mushrooming around screw head after installation

Finish: Exterior/Gray					 #2 Square  Cupped Pan  Sharp
Gauge	Length	Thread	Quantity	Item Code	
8	2½"	Multi-Thread	800 Tub	08S250W003	

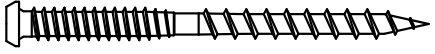
Finish: Exterior/Tan					
Gauge	Length	Thread	Quantity	Item Code	
8	2½"	Multi-Thread	800 Tub	08S250W592	

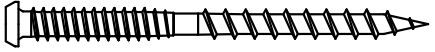



Finish: Exterior/Brown					
Gauge	Length	Thread	Quantity	Item Code	
8	2½"	Multi-Thread	800 Tub	08S250W497	













\*ICC certified test data available on all highlighted items. Refer to ESR-3558 for details.





## Metal to Metal Screws





General purpose screws for fastening metal to metal

Finish: Clear Zinc					 #2 Square  Flat Pan  Drill 
Gauge	Length	Thread	Quantity	Item Code	
10	¾"	Fine	1000 Tub	10M075CTMFDS*	
10	1"	Fine	1000 Box	10M100CKMFD5*	

Finish: Yellow Zinc					 Rex  Flat Pan  Drill 
Gauge	Length	Thread	Quantity	Item Code	
10	¾"	Fine	1000 Tub	10M075YTFDFX*	

Finish: Yellow Zinc					 Rex  Flat Pan  T4 Drill 
Gauge	Length	Thread	Quantity	Item Code	
10	¾"	22 TPI	8000 Loose	10M075YLF4X*	
10	¾"	22 TPI	1000 Box	10M075YKFT4X*	

Finish: Yellow Zinc					 Rex  Flat Pan  T4 Drill 
Gauge	Length	Thread	Quantity	Item Code	
12	¾"	Fine	1000 Box	12M087YKFF4X*	



Finish: Yellow Zinc					 Rex  Flat Pan  T3 Drill 
Gauge	Length	Thread	Quantity	Item Code	
12	1"	Fine	1000 Box	12M100YKFF3X*	





# COLLATED SCREWS

## Low Profile Framing Screws



**Self tapping metal framing screw**



Finish: Clear Zinc  

 #2 Phillips  Mod Truss  Sharp

Gauge	Length	Thread	Quantity	Item Code
8	1/2"	Fine	1000 Tub	08M050CTRFSP*
10	3/4"	Fine	1000 Box	10M075CSK

**Self drilling and tapping metal framing screws**

Finish: Clear Zinc  

 #2 Phillips  Mod Truss  Drill

Gauge	Length	Thread	Quantity	Item Code
8	1/2"	Fine	1000 Tub	08M050CTRFDP*
10	3/4"	22 TPI	1000 Box	10M075CDK



## 10M075CDK 22 TPI Metal Framing Screw





- Low profile head to reduce drywall flexing
- Higher thread count for better fastener engagement

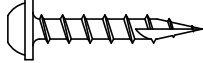

## Specialty Screws



**General purpose screws for a range of applications including window installation and crating**

Finish: Clear Zinc  



 #2 Square  Round Washer  Type 17



Gauge	Length	Thread	Quantity	Item Code
8	1 1/4"	Coarse	4000 Box	08X125CBACTS

Finish: Clear Zinc  

 #2 Square  Round Washer  Drill

Gauge	Length	Thread	Quantity	Item Code
8	1 1/4"	Double	1000 Box	08X125CKADD5*
8	2"	Double	1000 Box	08X200CKADD5*

Finish: Clear Zinc  

 #2 Square  Pan Framing  Sharp

Gauge	Length	Thread	Quantity	Item Code
8	1"	Double	4000 BOX	08M100CBPDSS





## Bits for Current Tools

Integrated auto-feed screwdriver — 2 or 25 bits per pack*			
Bits Fit	⊕ ITEM #	◻ ITEM #	⊛ ITEM #
DS222-18V DS225-18V DS242-AC DS245-AC	EA0297 EA0297N*	EA0298 EA0298N*	EA0299 EA0299N*
DS322-18V DS342-AC	EA0400	EA0401	EA0402
Auto-feed attachments and kits — 2 or 25 bits per pack*			
Bits Fit	⊕ ITEM #	◻ ITEM #	⊛ ITEM #
DS230	EA0300	EA0301 EA0301N*	EA0302
DS530 DS532-AC DS534-AC	EA0314	EA0315 EA0315N*	EA0316 EA0316N*
For PAMFast auto-feed screw system — 25 bits per pack			
Bits Fit	⊕ ITEM #	◻ ITEM #	⊛ ITEM #
1"-3" Models	-	EA0396	EA0397



\*25 count high torque bits for use in metal applications

## Bit Tip

Loose screwdriver — 10 bits per pack	
Bits Fit	⊛ ITEM #
SG2510 SG4100	EA0308



## DS530 Series Adapters

For attaching screwdrivers to DS530 attachments			
Screwdriver	Fits Tools		Adapter ITEM #
SENCO	SG2510	SG4100	MB0184
DeWalt	DW252 DW253 DW255 DW257	DW266 DW272 DW276	MB0185
	DCF624		MB0183
MAKITA	FS2200 FS2500 FS4200 FS6200	XSF03 XSF04 XSF05	MB0186
	FS2701		MB0187



## Bits for Retired Tools

Integrated auto-feed screwdriver — 2 bits per pack			
Bits Fit	⊕ ITEM #	◻ ITEM #	⊛ ITEM #
DS232-AC DS235-AC DS212-18V DS215-18V	EA0297	EA0298	EA0299
DS332-AC DS312-18V	EA0300	EA0301	EA0302
DS425-AC DS440-AC	EA0314	EA0315	EA0316
When attaching to SG2510, SG4100 and Makita with ADP019 & MB0174			
Bits Fit	⊕ ITEM #	◻ ITEM #	⊛ ITEM #
DS220	EA0311	EA0312	EA0313
DS320	EA0314	EA0315	EA0316
When attaching to DeWalt with ADP009			
Bits Fit	⊕ ITEM #	◻ ITEM #	⊛ ITEM #
DS220	EA0317	EA0318	EA0319
DS320	EA0320	EA0321	EA0322

## DS220 and DS320 Adapters

For attaching screwdrivers to DS220 and DS320 attachments			
Screwdriver	Fits Tools		Adapter ITEM #
SENCO	SG2510	SG4100	MB0173
DeWalt	DW252 DW253 DW255 DW257	DW266 DW272 DW276	ADP009
MAKITA	FS2200 FS2500 FS4200 FS6200	XSF03 XSF04 XSF05	ADP019
	FS2701		MB0174

# SCREW SYSTEM ACCESSORIES

## Nosepieces for Current and Retired Tools

For wood applications		
Fits Tools	Range	ITEM #
DS222-18V DS225-18V DS220 DS230 DS242-AC DS245-AC	1"-2"	FB0157
DS320 DS322-18V DS342-AC DS425AC DS440AC DS530 DS532-AC DS534-AC	1"-3"	FB0159



For metal framing applications		
Fits Tools	Range	ITEM #
DS222-18V DS225-18V DS220 DS230 DS242-AC DS245-AC	½"-1"	FB0155
DS220 DS230 DS222-18V DS225-18V DS242-AC DS245-AC	½"-1"	FC0822*
DS320 DS322-18V DS342-AC DS425AC DS440AC DS530 DS532-AC DS534-AC	½"-1"	FC0887*



For general applications		
Fits Tools	Range	ITEM #
DS222-18V DS225-18V DS220 DS230 DS242-AC DS245-AC	1"-2"	FC1022
DS320 DS322-18V DS342-AC DS425AC DS440AC DS530 DS532-AC DS534-AC	1"-3"	FC1023



For drywall applications		
Fits Tools	Range	ITEM #
DS220	1"-2"	FC0878
DS320 DS425AC DS440AC	1"-3"	FC0895





\*Not recommended for screws exceeding 1"

## Rubber & Sand Paper Replacement Pads

ITEM #	Description	Quantity	Fits Nosepiece
FC0983	Round no-mar pad with adhesive	3	FC0822, FC0887
FA0334	Square non-skid pad with adhesive	3	FB0157, FB0159



## Li-Ion Batteries

For use with 18V Li-Ion DuraSpin and SENCO FUSION tools		
18V Li-Ion Battery 1.5 amp hour	For use with	
VB0155	DS222-18V DS225-18V DS322-18V	 <ul style="list-style-type: none"> <li>• 1.5 amp hour</li> <li>• High-quality reliable cells</li> <li>• Longer storage life</li> <li>• Charges to 80% in 15 minutes</li> </ul>
VB0190		 <ul style="list-style-type: none"> <li>• 3.0 amp hour</li> <li>• State of the art 21700 cells</li> <li>• Longer storage life</li> <li>• Drives more than 2X the fasteners as VB0155 (above)</li> </ul>

## Battery Chargers

For use with SENCO batteries		
Battery Charger	For use with	
VB0156	VB0155 VB0190**	 <ul style="list-style-type: none"> <li>• 3 amp quick charger</li> <li>• Battery charge indicators display charge status of your battery</li> </ul>
VB0189	VB0155 VB0190	 <ul style="list-style-type: none"> <li>• 5 amp quick charger</li> <li>• Upright design is ideal for wall mounting</li> </ul>

\*\*The VB0189 charger is recommended for the VB0190 battery; using the VB0156 charger will result in longer charge times.

# FINISH & WOODWORKING

## THE DIFFERENCE IS IN THE DETAILS

Experience award-winning cordless convenience in all-day, everyday trim tools. Available in 15, 16 and 18 gauge, cordless pneumatic tools from SENCO feature a patented Fusion cordless air-power technology.

### APPLICATIONS

Finish and trim, fine woodworking, cabinet, furniture, decorative trim

### KEY FEATURES

- Rugged aluminum magazine
- Selectable drive switch allows for contact or sequential trigger actuation
- Nose-mounted LED light
- Adjustable belt hook
- Thumbwheel depth-of-drive
- EZ-Clear feature for quickly clearing jams
- Includes storage bag, battery and charger

SESCO has set the industry standard for pneumatic finish and fine woodworking tools, providing compact, ultra-light, easy-to-use tools designed for precision and longevity.

We offer a broader range of tools than anyone else, covering 15–23 gauge nailers and 16–19 gauge staplers, including the industry benchmark FinishPro®42XP.

### APPLICATIONS

Cabinetry, furniture, decorative trim, crown molding, custom woodworking applications and all other finish needs

### KEY FEATURES

- EZ-Clear™ latch to clear jams fast
- No-mar pads to protect woodwork
- Clear line-of-sight for precision fastening
- Comfort grip
- Adjustable depth-of-drive





## F-18XP

2 1/8" 18 GA. CORDLESS PNEUMATIC BRAD NAILER

ITEM #10M0001N

18<sup>GA</sup>



### Features

- Fusion cordless air-power technology
- Sequential or bump fire modes
- Tool-free depth-of-drive
- Includes one Li-ion battery, quick charge battery charger and storage bag

## F-15XP

2 1/2" 15 GA. CORDLESS PNEUMATIC FINISH NAILER

ITEM #10L0001N

15<sup>GA</sup>  
34°



### Features

- Fusion cordless air-power technology
- Sequential or bump fire modes
- Tool-free depth-of-drive
- Includes one Li-ion battery, quick charge battery charger and storage bag

## F-16XP

2 1/2" 16 GA. CORDLESS PNEUMATIC FINISH NAILER

ITEM #10N0001N

16<sup>GA</sup>



### Features

- Fusion cordless air-power technology
- Sequential or bump fire modes
- Tool-free depth-of-drive
- Includes one Li-ion battery, quick charge battery charger and storage bag

## F-LXP

1 1/2" 18 GA. 1/4" CROWN CORDLESS PNEUMATIC FINISH STAPLER

ITEM #10Y0001N

18<sup>GA</sup>



### Features

- Fusion cordless air-power technology
- Sequential or bump fire modes
- Tool-free depth-of-drive
- Includes one Li-ion battery, quick charge battery charger and storage bag

## Product Reference Chart

TOOL SPECS	F-18XP	F-16XP	F-15XP	F-LXP
<b>Weight with Battery</b>	6.6 lbs (3.0 kg)	6.7 lbs (3.1 kg)	6.8 lbs (3.1 kg)	6.8 lbs (3.1 kg)
<b>Height</b>	12.5" (318 mm)	12.5" (318 mm)	12.5" (318 mm)	12.5" (318 mm)
<b>Length</b>	10.2" (259 mm)	11.6" (295 mm)	12.6" (320 mm)	10.4" (264 mm)
<b>Width</b>	3.9" (99 mm)	3.9" (99 mm)	5.3" (135 mm)	3.9" (99 mm)
<b>Charge Time</b>	80% in 15 minutes, 100% in 45 minutes			
<b>Warranty</b>	5 yrs	5 yrs	5 yrs	5 yrs
<b>FASTENER SPECS</b>	Fasteners are located on pages 23-25, 27			
<b>Gauge, Gauge/Crown</b>	18	16	15	18/1/4"
<b>Range</b>	5/8"-2 1/8"	3/4"-2 1/2"	1 1/4"-2 1/2"	3/8"-1 1/2"
<b>Capacity</b>	110	110	110	110
<b>Angle/Collation</b>	Straight Glued Strip	Straight Glued Strip	34° Angled Taped Strip	Straight Glued Strip
<b>Series</b>	AY, AX	M0	DA	L
<b>TOOL FEATURES</b>				
<b>Jam Reduction Intelligence</b>	Yes	Yes	Yes	Yes
<b>Depth-of-Drive</b>	Yes, Tool-Free	Yes, Tool-Free	Yes, Tool-Free	Yes, Tool-Free
<b>EZ-Clear Jam Clearing</b>	No	No	Yes	No
<b>Trigger Actuation</b>	Sequential or Contact	Sequential or Contact	Sequential or Contact	Sequential or Contact
<b>Nose Mounted LED Light</b>	Yes	Yes	Yes	Yes
<b>Belt Hook</b>	Adjustable and Reversible	Adjustable and Reversible	Adjustable and Reversible	Adjustable and Reversible

### TN11G1

1 3/8" HEADLESS PINNER



23<sub>GA</sub>

#### Features

- Neverlube® oil-free design
- Magazine automatically adjusts for fastener length
- Ergonomic angled "pistol-grip" handle
- Ultra-narrow nosepiece
- Reversible belt hook
- Last nail lockout

### TN11L1

2" HEADLESS PINNER



23<sub>GA</sub>

#### Features

- Neverlube® oil-free design
- Magazine automatically adjusts for fastener length
- Ergonomic angled "pistol-grip" handle
- Ultra-narrow nosepiece
- Reversible belt hook
- Last nail lockout

### The Details Matter

Neverlube® oil-free tools are designed for maintenance-free operation, eliminating the risk of oil spillover onto the work surface.



### Product Reference Chart

TOOL SPECS	TN11G1	TN11L1
<b>Trigger</b>	Sequential	Sequential
<b>Operating Pressure</b>	70-100 psi (4.8-6.9 bar)	70-110 psi (4.8-7.6 bar)
<b>Air Consumption</b> (60 CPM)	1.1 scfm	1.1 scfm
<b>Air Inlet</b>	1/4" NPT	1/4" NPT
<b>Weight</b>	2.41 lbs (1.09 kg)	2.86 lbs (1.3 kg)
<b>Height</b>	7.8" (198 mm)	9.2" (233 mm)
<b>Length</b>	8.57" (218 mm)	8.69" (220 mm)
<b>Width</b>	2.6" (66 mm)	2.6" (66 mm)
<b>Main Body Material</b>	Aluminum	Aluminum
<b>Warranty</b>	5 yrs	5 yrs
<b>FASTENER SPECS</b>	Fasteners are located on page 23	
<b>Gauge</b>	23	23
<b>Range</b>	1/2" - 1 3/8"	1/2" - 2"
<b>Capacity</b>	100	100
<b>Angle/Collation</b>	Straight Glued Strip	Straight Glued Strip
<b>Series</b>	A1, CZ	A1, CZ
<b>TOOL FEATURES</b>		
<b>Depth-of-Drive</b>	No	No
<b>Belt Hook</b>	Yes	Yes
<b>NeverLube®</b>	Yes	Yes
<b>Exhaust</b>	Rear	Rear

## TN21L1

2" PINNER



21<sub>GA</sub>

### Features

- Neverlube® oil-free design
- Magazine automatically adjusts for fastener length
- Ergonomic angled "pistol-grip" handle
- Ultra-narrow nosepiece
- Reversible belt hook
- Last nail lockout

## LS1XP

1" HEADLESS BRAD NAILER

ITEM #8N0001N



18<sub>GA</sub>

### Features

- Never-Lube® design — no lubrication to stain fine woods
- Ergonomic handle for all-day comfort
- Narrow nose for tight corners

## FinishPro®18Mg

2½" BRAD NAILER

ITEM #1U0021N



18<sub>GA</sub>

### Features

- Metal cylinder for increased durability
- EZ-Clear™ latch virtually eliminates downtime caused by fastener jams
- Narrow nose for tight corners
- Includes case, swivel air plug and wrench

## FinishPro®18BMg

2½" BRAD NAILER

ITEM #9B0001N



18<sub>GA</sub>

### Features

- Oil-free design — no oil required
- Ultra-lightweight for ease of use and maneuverability
- Nose mounted LED light illuminates dark work spaces
- Includes case, swivel air plug and wrench

## Product Reference Chart

TOOL SPECS	TN21L1	LS1XP	FinishPro®18Mg	FinishPro®18BMg
<b>Trigger</b>	Sequential	Sequential	Selectable	Selectable
<b>Operating Pressure</b>	70-110 psi (4.8-7.6 bar)	70-120 psi (4.8-8.3 bar)	70-120 psi (4.8-8.3 bar)	70-120 psi (4.8-8.3 bar)
<b>Air Consumption</b> (60 CPM)	1.1 scfm	1.92 scfm	2.4 scfm	1.6 scfm
<b>Air Inlet</b>	¼" NPT	¼" NPT	¼" NPT	¼" NPT
<b>Weight</b>	3.16 lbs (1.43 kg)	2.9 lbs (1.3 kg)	2.48 lbs (1.12 kg)	2.8 lbs (1.26 kg)
<b>Height</b>	9.2" (233 mm)	8.25" (210 mm)	9.75" (248 mm)	9.8" (248 mm)
<b>Length</b>	8.76" (222 mm)	9" (229 mm)	10.5" (267 mm)	10" (255 mm)
<b>Width</b>	2.6" (66 mm)	2" (51 mm)	2.5" (63.5 mm)	2.5" (63.5 mm)
<b>Main Body Material</b>	Aluminum	Aluminum	Magnesium	Magnesium
<b>Warranty</b>	5 yrs	5 yrs	5 yrs	5 yrs
<b>FASTENER SPECS</b>	Fasteners are located on pages 23-24			
<b>Gauge</b>	21	18	18	18
<b>Range</b>	⅝"-2"	½"-1"	⅝"-2⅛"	⅝"-2⅛"
<b>Capacity</b>	200	100	110	100
<b>Angle/Collation</b>	Straight Glued Strip	Straight Glued Strip	Straight Glued Strip	Straight Glued Strip
<b>Series</b>	ZX	AZ	AX	AX
<b>TOOL FEATURES</b>				
<b>Depth-of-Drive</b>	No	No	Yes, Tool-Free	Yes, Tool-Free
<b>Belt Hook</b>	Yes	Fixed	Yes	Yes
<b>NeverLube®/Oil-Less</b>	NeverLube®	NeverLube®	Oil-Less	Oil-Less
<b>Exhaust</b>	Rear	Fixed	Rear Adjustable	Rear Adjustable



## SLP20XP

1 5/8" BRAD NAILER

ITEM #430101N



18<sub>GA</sub>

### Features

- Never-Lube® design — no oil required
- Drives both slight and medium headed brads
- Muffler ensures quieter operation
- Includes case

## FinishPro®16XP

2 1/2" FINISH NAILER

ITEM #9S0001N



16<sub>GA</sub>

### Features

- Redesigned EZ-Clear™ latch for quick and easy jam clearing
- Upgraded magazine feed system for consistent, reliable shot performance
- Selectable single fire and bump fire modes
- Tool free depth of drive adjustment

## FinishPro®25XP

2 1/8" BRAD NAILER

ITEM #760102N



18<sub>GA</sub>

### Features

- Never-Lube® design — no oil required
- Drives both slight and medium headed brads
- Powerful — ensures complete drives into hard substrates
- Includes case

## Product Reference Chart

TOOL SPECS	SLP20XP	FinishPro®25XP	FinishPro®16XP
<b>Trigger</b>	Sequential	Sequential	Selectable
<b>Operating Pressure</b>	70-120 psi (4.8-8.3 bar)	70-120 psi (4.8-8.3 bar)	70-120 psi (4.8-8.3 bar)
<b>Air Consumption</b> (60 CPM)	1.92 scfm	1.92 scfm	2.22 scfm
<b>Air Inlet</b>	1/4" NPT	1/4" NPT	1/4" NPT
<b>Weight</b>	2.3 lbs (1 kg)	2.7 lbs (1.2 kg)	4.0 lbs (1.8 kg)
<b>Height</b>	8.25" (210 mm)	9.9" (251 mm)	11.4" (290 mm)
<b>Length</b>	9.5" (241 mm)	9.8" (249 mm)	12" (305 mm)
<b>Width</b>	2" (50.8 mm)	2.2" (56 mm)	4" (102 mm)
<b>Main Body Material</b>	Aluminum	Aluminum	Magnesium
<b>Warranty</b>	5 yrs	5 yrs	5 yrs
FASTENER SPECS	Fasteners are located on pages 23-24		
<b>Gauge</b>	18	18	16
<b>Range</b>	5/8"-1 5/8"	5/8"-2 1/8"	1 1/4"-2 1/2"
<b>Capacity</b>	110	110	110
<b>Angle/Collation</b>	Straight Glued Strip	Straight Glued Strip	Straight Glued Strip
<b>Series</b>	AX, AY	AX, AY	A4, MO
TOOL FEATURES			
<b>Depth-of-Drive</b>	No	Yes, Tool-Free	Yes, Tool-Free
<b>Belt Hook</b>	No	Yes	Yes
<b>Oil-Less</b>	Yes	Yes	No
<b>Exhaust</b>	Fixed	Adjustable	Adjustable

## FinishPro® 30XP

2" ANGLED FINISH NAILER

ITEM #9P0002N



15<sup>GA</sup>  
34°

### Features

- Never-Lube® design — no oil required
- EZ-Clear™ latch virtually eliminates downtime caused by fastener jams
- Adjustable depth of drive
- Includes case and belt hook

## FinishPro® 35Mg

2½" ANGLED FINISH NAILER

ITEM #6G0001N



15<sup>GA</sup>  
34°

### Features

- EZ-Clear™ latch virtually eliminates downtime caused by fastener jams
- Integrated air blower clears debris from work surface
- Metal cylinder for increased durability
- Includes case, swivel air plug and wrench

## FinishPro® 42XP

2½" ANGLED FINISH NAILER

ITEM #4G0001N



15<sup>GA</sup>  
34°

### Features

- Never-Lube® design — no oil required
- EZ-Clear™ latch virtually eliminates downtime caused by fastener jams
- High-strength driver with threaded connection
- Metal cylinder for increased durability
- Includes case, belt hook and contact trigger kit

## Product Reference Chart

TOOL SPECS	FinishPro®30XP	FinishPro®35Mg	FinishPro®42XP
<b>Trigger</b>	Sequential	Selectable	Sequential
<b>Operating Pressure</b>	70-120 psi (4.8-8.3 bar)	70-120 psi (4.8-8.3 bar)	70-120 psi (4.8-8.3 bar)
<b>Air Consumption</b> (60 CPM)	2.16 scfm	3.2 scfm	3.87 scfm
<b>Air Inlet</b>	¼" NPT	¼" NPT	¼" NPT
<b>Weight</b>	3.8 lbs (1.73 kg)	4.2 lbs (1.9 kg)	4.7 lbs (2.1 kg)
<b>Height</b>	9.63" (244.6 mm)	12.25" (311 mm)	11.25" (286 mm)
<b>Length</b>	12" (305 mm)	13" (330 mm)	13" (330 mm)
<b>Width</b>	3.25" (82.5 mm)	3.5" (89 mm)	3.5" (89 mm)
<b>Main Body Material</b>	Magnesium	Magnesium	Magnesium
<b>Warranty</b>	5 yrs	5 yrs	5 yrs
<b>FASTENER SPECS</b>	Fasteners are located on page 25		
<b>Gauge</b>	15	15	15
<b>Range</b>	1"-2"	1¼"-2½"	1¼"-2½"
<b>Capacity</b>	104	110	104
<b>Angle/Collation</b>	34° Angled Tape Strip	34° Angled Tape Strip	34° Angled Tape Strip
<b>Series</b>	DA	DA	DA
<b>TOOL FEATURES</b>			
<b>Depth-of-Drive</b>	Yes, Tool-Free	Yes, Tool-Free	Yes, Tool-Free
<b>Belt Hook</b>	Yes	Yes	Yes
<b>Oil-Less</b>	Yes	Yes	Yes
<b>Exhaust</b>	Fixed	Adjustable	Adjustable

## SLS20XP

3/16", 1/4", 3/8" CROWNS, 1 1/2" FINE/MEDIUM WIRE STAPLER

SEE ITEM # CHART



19<sub>GA</sub> 18<sub>GA</sub>

### Features

- Never-Lube® design — no oil required
- Ultra-lightweight for ease of use and maneuverability
- Metal cylinder for increased durability
- Muffler ensures quieter operation

## SLS25XP

1/4", 3/8" CROWNS, 1 1/2" MEDIUM WIRE STAPLER

SEE ITEM # CHART



18<sub>GA</sub>

### Features

- Never-Lube® design — no oil required
- Ultra-lightweight for ease of use and maneuverability
- Metal cylinder for increased durability
- Muffler ensures quieter operation

## SKSXP

1/4", 3/8", 7/16" CROWNS, 1 1/2" MEDIUM/HEAVY WIRE STAPLER

SEE ITEM # CHART



18<sub>GA</sub> 16<sub>GA</sub>

### Features

- Never-Lube® design — no oil required
- EZ-Clear™ latch virtually eliminates downtime caused by fastener jams
- Long 1" lip to get into tight spots

### SLS20XP, SLS25XP and SKSXP Item Code Chart

Model	Crown	Item Code
SLS20XP-K	1/4"	490101N
SLS20XP-L	1/4"	490103N
SLS20XP-L W/CASE	1/4"	490105N
SLS20XP-L SENCOMATIC	1/4"	490015N
SLS20XP-M	3/8"	490107N
SLS20XP-R	3/16"	490111N
SLS25XP-L	1/4"	820103N
SLS25XP-M	3/8"	820107N
SKSXP-L	1/4"	300120N
SKSXP-M	3/8"	300152N
SKSXP-N	7/16"	300184N

## Product Reference Chart

TOOL SPECS	SLS20XP	SLS25XP	SKSXP
<b>Trigger</b>	Sequential	Contact	Sequential
<b>Operating Pressure</b>	70-120 psi (4.8-8.3 bar)	70-120 psi (4.8-8.3 bar)	70-120 psi (4.8-8.3 bar)
<b>Air Consumption</b> (60 CPM)	1.92 scfm	1.92 scfm	2.16 scfm
<b>Air Inlet</b>	1/4" NPT	1/4" NPT	1/4" NPT
<b>Weight</b>	2.5 lbs (1.13 kg)	2.67 lbs (1.21 kg)	4.2 lbs (1.9 kg)
<b>Height</b>	8.5" (216 mm)	9" (229 mm)	9.25" (238 mm)
<b>Length</b>	12" (305 mm)	12" (305 mm)	12.38" (314 mm)
<b>Width</b>	2" (50.8 mm)	2" (50.8 mm)	3" (76 mm)
<b>Main Body Material</b>	Aluminum	Aluminum	Aluminum
<b>Warranty</b>	5 yrs	5 yrs	5 yrs
<b>FASTENER SPECS</b>	Fasteners are located on pages 26-28		
<b>Gauge</b>	19, 18	18	18, 16
<b>Crown</b>	3/16", 1/4", 3/8"	1/4", 3/8"	1/4", 3/8", 7/16"
<b>Range</b>	3/8"-1 1/2"	3/8"-1 1/2"	3/4"-1 1/2"
<b>Capacity</b>	168	168	145
<b>Angle/Collation</b>	Straight Glued Strip	Straight Glued Strip	Straight Glued Strip
<b>Series</b>	K, L, M, R	L, M	L, M, N
<b>TOOL FEATURES</b>			
<b>Depth-of-Drive</b>	Yes	Yes	No
<b>Belt Hook</b>	No	No	No
<b>Oil-Less</b>	Yes	Yes	Yes



## SLS150Mg

¼" CROWN, 1⅞" MEDIUM WIRE STAPLER

ITEM #8C0001N



18<sub>GA</sub>

### Features

- Ultra-lightweight for ease of use and maneuverability
- Nose-mounted LED light — illuminates work surface
- Durable composite magazine
- Reload indicator on magazine
- Includes case and wrench

## SLS18Mg

¼" CROWN, 1½" MEDIUM WIRE STAPLER

ITEM #1W0021N



18<sub>GA</sub>

### Features

- Ultra-lightweight for ease of use and maneuverability
- Metal cylinder for increased durability
- Reload indicator on magazine
- Includes case, swivel air plug and wrench

## Product Reference Chart

TOOL SPECS	SLS150Mg	SLS18Mg
<b>Trigger</b>	Selectable	Selectable
<b>Operating Pressure</b>	70-120 psi (4.8-8.3 bar)	70-120 psi (4.8-8.3 bar)
<b>Air Consumption</b> (60 CPM)	2.4 scfm	2.4 scfm
<b>Air Inlet</b>	¼" NPT	¼" NPT
<b>Weight</b>	2.6 lbs (1.8 kg)	2.6 lbs (1.8 kg)
<b>Height</b>	9.5" (241 mm)	9.5" (241 mm)
<b>Length</b>	10.25" (260 mm)	10.25" (260 mm)
<b>Width</b>	2.5" (63.5 mm)	2.5" (63.5 mm)
<b>Main Body Material</b>	Magnesium	Magnesium
<b>Warranty</b>	5 yrs	5 yrs
FASTENER SPECS	Fasteners are located on page 27	
<b>Gauge</b>	18	18
<b>Crown</b>	¼"	¼"
<b>Range</b>	½"-1⅞"	⅜"-1½"
<b>Capacity</b>	110	110
<b>Angle/Collation</b>	Straight Glued & Taped Strip	Straight Glued & Taped Strip
<b>Series</b>	L	L
TOOL FEATURES		
<b>Depth-of-Drive</b>	Yes, Tool-Free	Yes, Tool-Free
<b>Belt Hook</b>	Yes	Yes
<b>Oil-Less</b>	Yes	Yes

## SC1XP Senclamp®

7/16" CROWN, 9/16" SENCLAMP® FASTENER

ITEM #220101N

25<sub>GA</sub>

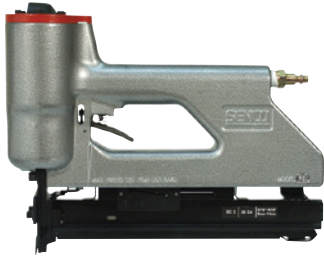

### Features

- Senclamp® fasteners pull the joint together during driving for a tight, permanent fit
- Eliminates milling, doweling, clamping, screwing and other time-consuming, cost-adding operations
- The Senclamp high-carbon steel fastener derives added strength from its special webbed design

## SC2 Sencor®

1" CROWN, 1/2" CORRUGATED STAPLER

ITEM #470001N

25<sub>GA</sub>

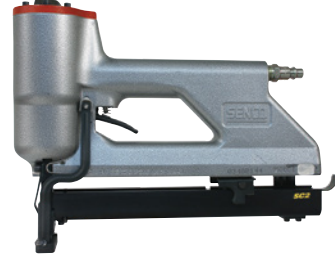

### Features

- Powerful — ensures complete drives into hard substrates
- Eliminates gluing, milling, doweling, screwing and clamping
- Added strength for larger butt joints

## Product Reference Chart

TOOL SPECS	SC1XP Senclamp®	SC2 Sencor®
<b>Trigger</b>	Sequential	Sequential
<b>Operating Pressure</b>	80-110 psi (5.5-7.5 bar)	80-110 psi (5.5-7.5 bar)
<b>Air Consumption</b> (60 CPM)	3.8 scfm	3.7 scfm
<b>Air Inlet</b>	3/8" NPT	3/8" NPT
<b>Weight</b>	6.3 lbs (2.8 kg)	6.9 lbs (3.1 kg)
<b>Height</b>	9.8" (249 mm)	9.44" (240 mm)
<b>Length</b>	12.7" (322 mm)	12.5" (318 mm)
<b>Width</b>	2.5" (63.5 mm)	2" (50.8 mm)
<b>Main Body Material</b>	Aluminum	Aluminum
<b>Warranty</b>	5 yrs	5 yrs
<b>FASTENER SPECS</b>	Fasteners are located on page 29	
<b>Gauge</b>	25	25
<b>Crown</b>	7/16"	1"
<b>Range</b>	5/16" - 9/16"	1/4" - 1/2"
<b>Capacity</b>	120	80
<b>Angle/Collation</b>	Straight Glued & Taped Strip	Straight Glued Strip
<b>Series</b>	Y	X
<b>TOOL FEATURES</b>		
<b>Depth-of-Drive</b>	No	No
<b>Belt Hook</b>	No	No
<b>Oil-Less</b>	No	No

# FINISH & WOODWORKING FASTENERS

23<sub>GA</sub>

## Headless Straight Strip Pins

Pins fasten the smallest of trim securely leaving a nearly invisible hole

Length	Point	Head	Finish	Coating	Collation	Box Count	Item Code
1/2"	Chisel	Headless	Galv	Plain	Straight Glued Strip	15.5M	CZ08EAA
5/8"	Chisel	Headless	Galv	Plain	Straight Glued Strip	10M	CZ10EAA
3/4"	Chisel	Headless	Galv	Plain	Straight Glued Strip	15.5M	CZ10EAA
3/4"	Chisel	Headless	Galv	Plain	Straight Glued Strip	10M	CZ11EAA
3/4"	Chisel	Headless	Galv	Plain	Straight Glued Strip	15.5M	CZ11EAA
1"	Chisel	Headless	Galv	Plain	Straight Glued Strip	10M	CZ13EAA
1 1/4"	Chisel	Headless	Galv	Plain	Straight Glued Strip	10M	CZ15EAA
1 3/8"	Chisel	Headless	Galv	Plain	Straight Glued Strip	10M	CZ16EAA
1 1/2"	Chisel	Headless	Galv	Plain	Straight Glued Strip	10M	CZ17EAA
2"	Chisel	Headless	Galv	Plain	Straight Glued Strip	10M	CZ21EAA
1/2"	Chisel	Headless	Galv	Plain	Straight Glued Strip	2.6M (CS)	A100509
3/8"	Chisel	Headless	Galv	Plain	Straight Glued Strip	2.6M (CS)	A100629
3/4"	Chisel	Headless	Galv	Plain	Straight Glued Strip	2.6M (CS)	A100759
1"	Chisel	Headless	Galv	Plain	Straight Glued Strip	2.6M (CS)	A101009
1 1/4"	Chisel	Headless	Galv	Plain	Straight Glued Strip	2.6M (CS)	A101259
1 3/8"	Chisel	Headless	Galv	Plain	Straight Glued Strip	2.6M (CS)	A101379
1 1/2"	Chisel	Headless	Galv	Plain	Straight Glued Strip	2.6M (CS)	A101509
2"	Chisel	Headless	Galv	Plain	Straight Glued Strip	2.6M (CS)	A102009
1/2"-1"	Chisel	Headless	Galv	Plain	Straight Glued Strip	2.5M (CS)	A109809*
1"-2"	Chisel	Headless	Galv	Plain	Straight Glued Strip	2.5M (CS)	A109909*

CS-Clamshell, \*Variety Pack

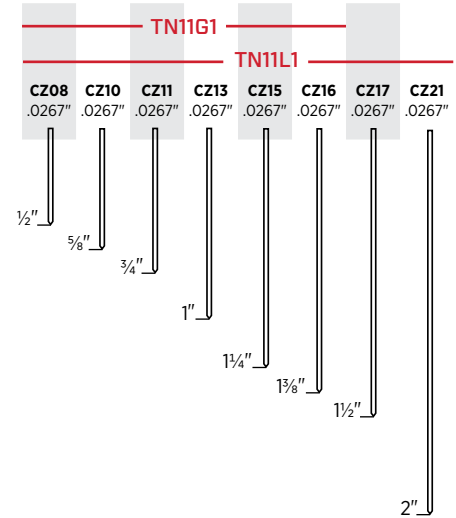

21<sub>GA</sub>

## Medium Straight Strip Head Pins

21 gauge pins offer significantly more holding power than 23 gauge pins while leaving a much smaller indent than an 18 gauge brad

Length	Point	Head	Finish	Coating	Collation	Box Count	Item Code
5/8"	Chisel	Medium	Galv	Plain	Straight Glued Strip	5M	ZX10EAA
1"	Chisel	Medium	Galv	Plain	Straight Glued Strip	5M	ZX13EAA
1 3/8"	Chisel	Medium	Galv	Plain	Straight Glued Strip	5M	ZX16EAA
1 5/8"	Chisel	Medium	Galv	Plain	Straight Glued Strip	5M	ZX18EAA
2"	Chisel	Medium	Galv	Plain	Straight Glued Strip	5M	ZX21EAA

CS-Clamshell

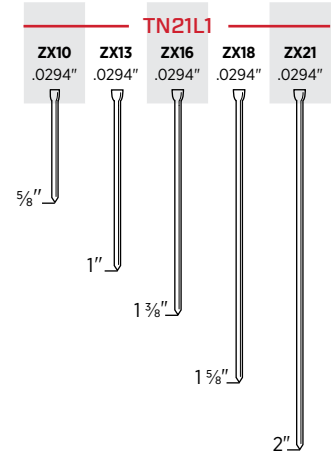

18<sub>GA</sub>

## Straight Strip Brad Nails

Cabinets, decorative trim, picture frames and molding

Length	Point	Head	Finish	Coating	Collation	Box Count	Item Code
5/8"	Chisel	Medium	Galv	Plain	Straight Glued Strip	5M	AX10EAA
3/4"	Chisel	Medium	Galv	Plain	Straight Glued Strip	5M	AX11EAA
1"	Chisel	Medium	Galv	Plain	Straight Glued Strip	5M	AX13EAA
1 1/4"	Chisel	Medium	Galv	Plain	Straight Glued Strip	5M	AX15EAA
1 1/2"	Chisel	Medium	Galv	Plain	Straight Glued Strip	5M	AX17EAA
1 5/8"	Chisel	Medium	Galv	Plain	Straight Glued Strip	5M	AX18EAA
1 3/4"	Chisel	Medium	Galv	Plain	Straight Glued Strip	5M	AX19EAA
2"	Chisel	Medium	Galv	Plain	Straight Glued Strip	5M	AX21EAA
2 1/8"	Chisel	Medium	Galv	Plain	Straight Glued Strip	5M	AX22EAA
1"	Chisel	Medium	Galv	Plain	Straight Glued Strip	1M (CS)	A201009
1 1/4"	Chisel	Medium	Galv	Plain	Straight Glued Strip	1M (CS)	A201259
1 1/2"	Chisel	Medium	Galv	Plain	Straight Glued Strip	0.8M (CS)	A201509
2"	Chisel	Medium	Galv	Plain	Straight Glued Strip	0.8M (CS)	A202009
5/8"-1 1/4"	Chisel	Medium	Galv	Plain	Straight Glued Strip	1.2M (CS)	A209809*
1-2"	Chisel	Medium	Galv	Plain	Straight Glued Strip	1.2M (CS)	A209909*

CS-Clamshell, \*Variety Pack

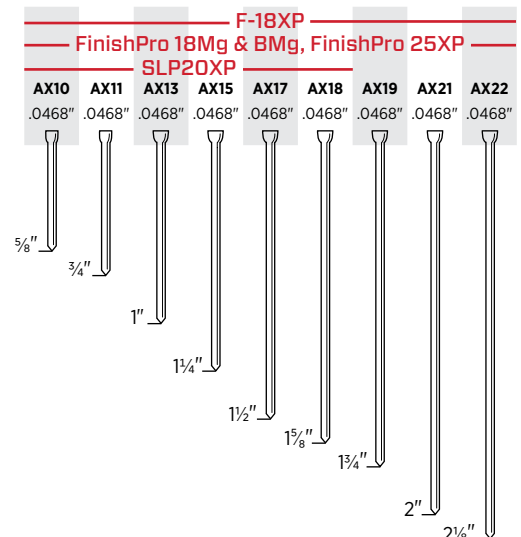



18<sup>GA</sup>

## Headless and Slight Head Brad Nails

Cabinets, decorative trim, picture frames and molding

Length	Point	Head	Finish	Coating	Collation	Box Count	Item Code
½"	Chisel	Headless	Galv	Plain	Straight Glued Strip	5M	AZ08EAA
¾"	Chisel	Headless	Galv	Plain	Straight Glued Strip	5M	AZ11EAA
1"	Chisel	Headless	Galv	Plain	Straight Glued Strip	5M	AZ13EAA
⅝"	Chisel	Slight	Galv	Plain	Straight Glued Strip	5M	AY10EAA
¾"	Chisel	Slight	Galv	Plain	Straight Glued Strip	5M	AY11EAA
1"	Chisel	Slight	Galv	Plain	Straight Glued Strip	5M	AY13EAA

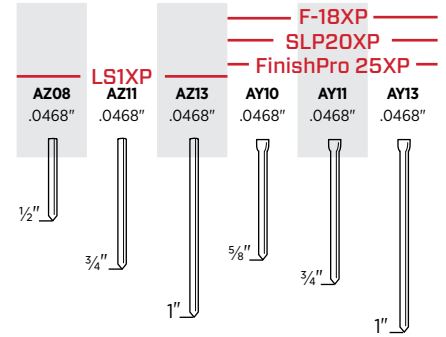

16<sup>GA</sup>

## Straight Strip Finish Nails

Furniture and cabinets, molding and trim, baseboard, chair rails, window casings and upholstery trim panels

Length	Point	Head	Finish	Coating	Collation	Box Count	Item Code
¾"	Chisel	T-head	Galv	Plain	Straight Glued Strip	2M	M001000
1"	Chisel	T-head	Galv	Plain	Straight Glued Strip	2M (PT)	M001001
1¼"	Chisel	T-head	Galv	Plain	Straight Glued Strip	2M (PT)	M001002
1½"	Chisel	T-head	Galv	Plain	Straight Glued Strip	2M (PT)	M001003
1¾"	Chisel	T-head	Galv	Plain	Straight Glued Strip	2M (PT)	M001004
2"	Chisel	T-head	Galv	Plain	Straight Glued Strip	2M (PT)	M001005
2½"	Chisel	T-head	Galv	Plain	Straight Glued Strip	2M (PT)	M001007
2"	Chisel	T-head	Galv	Plain	Straight Glued Strip	0.7M (CS)	A402009

CS-Clamshell, PT-Plastic Tub

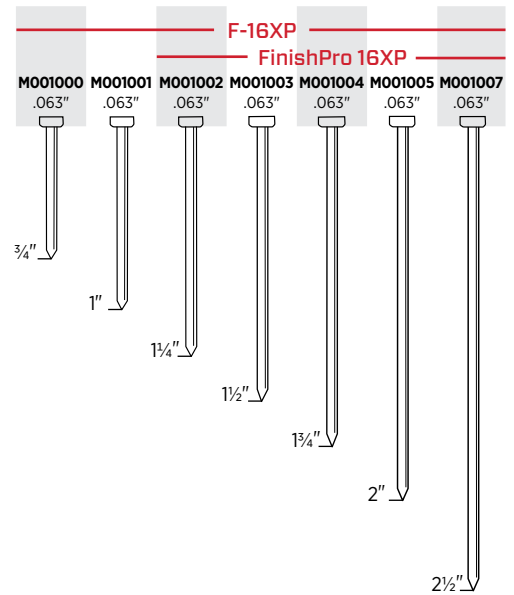

# FINISH & WOODWORKING FASTENERS

15<sup>GA</sup>  
34°

## Angled Strip Finish Nails

Furniture and cabinets, molding and trim, baseboard, chair rails, doors and window casings

Length	Point	Head	Finish	Coating	Collation	Box Count	Item Code
1"	Chisel	Brad	Bright	Sencote	34° Angled Tape Strip	4M	DA13EPBN
1¼"	Chisel	Brad	Bright	Sencote	34° Angled Tape Strip	4M	DA15EPBN
1½"	Chisel	Brad	Bright	Sencote	34° Angled Tape Strip	4M	DA17EPBN
1¾"	Chisel	Brad	Bright	Sencote	34° Angled Tape Strip	4M	DA19EPBN
2"	Chisel	Brad	Bright	Sencote	34° Angled Tape Strip	4M	DA21EPBN
2½"	Chisel	Brad	Bright	Sencote	34° Angled Tape Strip	4M	DA23EPBN
2½"	Chisel	Brad	Bright	Sencote	34° Angled Tape Strip	3M	DA25EPB
1½"	Chisel	Brad	Bright	Sencote	34° Angled Tape Strip	0.7M (CS)	A301500
1¾"	Chisel	Brad	Bright	Sencote	34° Angled Tape Strip	0.7M (CS)	A301750
2"	Chisel	Brad	Bright	Sencote	34° Angled Tape Strip	0.7M (CS)	A302000
2½"	Chisel	Brad	Bright	Sencote	34° Angled Tape Strip	0.7M (CS)	A302500
1¼"	Chisel	Brad	Galv	Sencote	34° Angled Tape Strip	4M	DA15EABN
1½"	Chisel	Brad	Galv	Sencote	34° Angled Tape Strip	4M	DA17EABN
1¾"	Chisel	Brad	Galv	Sencote	34° Angled Tape Strip	4M	DA19EABN
2"	Chisel	Brad	Galv	Sencote	34° Angled Tape Strip	4M	DA21EABN
2½"	Chisel	Brad	Galv	Sencote	34° Angled Tape Strip	3M	DA25EAB
2"	Chisel	Brad	Galv	Sencote	34° Angled Tape Strip	0.7M (CS)	A302009
2½"	Chisel	Brad	Galv	Sencote	34° Angled Tape Strip	0.7M (CS)	A302509
2"	Chisel	Brad	Stainless 304	Plain	34° Angled Tape Strip	2M	DA21EGBN
2½"	Chisel	Brad	Stainless 304	Plain	34° Angled Tape Strip	1.2M	DA25EGB
1¼"	Diamond	Brad	Hardened*	Plain	34° Angled Tape Strip	4M	DA15AIA
1½"	Diamond	Brad	Hardened*	Plain	34° Angled Tape Strip	4M	DA17AIA
1¾"	Diamond	Brad	Hardened*	Plain	34° Angled Tape Strip	4M	DA19AIA

CS-Clamshell

\*Hardened regular galvanized heat treated 15 Gauge for steel stud and trim applications

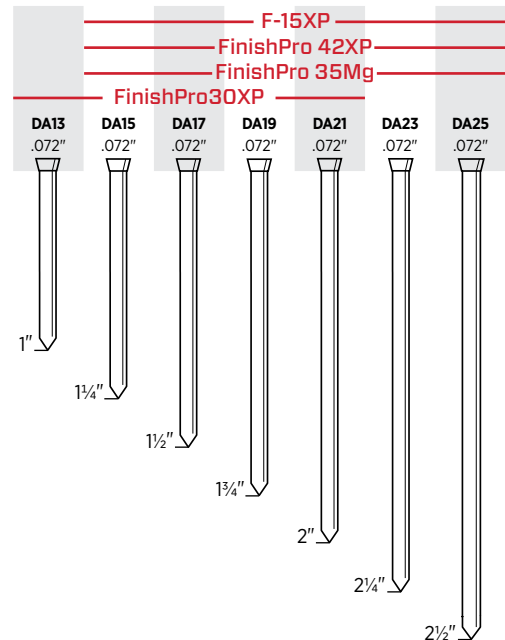

## The Best Finish Nails in the Business.

SENCO® has the finish nails to meet all your finish and trim needs. In addition to offering a wide variety of fastener ranges and gauges, we provide a full line of tools to drive them.



MAKING HARD WORK EASIER

## 19<sup>GA</sup> 1/4" Crown Medium Wire Staples

Cabinets, drawers, soffits, lattice, casebacks						
Length	Point	Finish	Coating	Collation	Box Count	Item Code
3/4"	Chisel	Galv	Sencote	Glued	10M	K11BAB
7/8"	Chisel	Galv	Sencote	Glued	5M	K12BAB
1"	Chisel	Galv	Sencote	Glued	5M	K13BABN

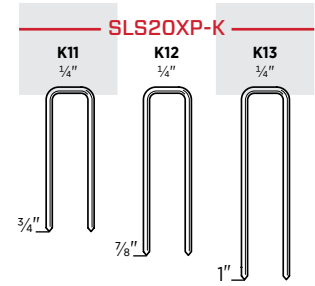

## 19<sup>GA</sup> 3/16" Crown Medium Wire Staples

Cabinets, drawers, lattice, laminated hardwood flooring						
Length	Point	Finish	Coating	Collation	Box Count	Item Code
1/2"	Blunt	Galv	Sencote	Glued	10M	R08BAB
5/8"	Blunt	Galv	Sencote	Glued	5M	R10BAB
3/4"	Blunt	Galv	Sencote	Glued	5M	R11BAB
1"	Blunt	Galv	Sencote	Glued	5M	R13BAB

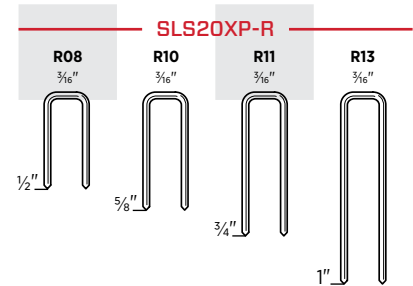

# FINISH & WOODWORKING FASTENERS

18<sup>GA</sup>

## 1/4" Crown Medium Wire Staples

Cabinets, casebacks, drawers, upholstery, soffits, underlayment, lattice and insulation sheathing

Length	Point	Finish	Coating	Collation	Box Count	Item Code
3/4"	Chisel	Bright	Sencote	Glued	5M	L11BRB
1"	Chisel	Bright	Sencote	Glued	5M	L13BRBN
1"	Chisel	Bright	Sencote	Glued	40M	L13BRBP
1 1/8"	Chisel	Bright	Sencote	Glued	5M	L14BRB
1 1/4"	Chisel	Bright	Sencote	Glued	5M	L15BRB
3/8"	Chisel	Galv	Sencote	Glued	10M	L06BAB
7/16"	Chisel	Galv	Sencote	Glued	24M	L07BABP
1/2"	Chisel	Galv	Sencote	Glued	10M	L08BAB
5/8"	Chisel	Galv	Sencote	Glued	5M	L10BABN
5/8"	Cross Cut	Galv	Sencote	Glued	5M	L10HABN
3/4"	Chisel	Galv	Sencote	Glued	5M	L11BAB
3/4"	Cross Cut	Galv <sup>1</sup>	Sencote	Glued	5M	L11HBB
3/4"	Cross Cut	Galv	Sencote	Glued	5M	L11HAB
7/8"	Chisel	Galv	Sencote	Glued	5M	L12BAB
7/8"	Chisel	Galv	Sencote	Glued	5M	L12QB
1"	Chisel	Galv	Sencote	Glued	5M	L13BABN
1"	Cross Cut	Galv	Sencote	Glued	5M	L13HABN
1 1/8"	Chisel	Galv	Sencote	Glued	5M	L14BAB
1 1/4"	Chisel	Galv	Sencote	Glued	5M	L15BAB
1 1/2"	Chisel	Galv	Sencote	Glued	5M	L17BAB
5/8"	Chisel	Galv	Sencote	Glued	1.2M (CS)	A800629
3/4"	Chisel	Galv	Sencote	Glued	0.9M (CS)	A800759
1"	Chisel	Galv	Sencote	Glued	0.9M (CS)	A801009
1 1/4"	Chisel	Galv	Sencote	Glued	0.7M (CS)	A801259
1 1/2"	Chisel	Galv	Sencote	Glued	0.6M (CS)	A801509
1/2"-1 1/2"	Chisel	Galv	Sencote	Glued	0.9M (CS)	A809909*
5/8"	Chisel	Stainless 304 <sup>2</sup>	Plain	Glued	5M	L10BHA
3/4"	Chisel	Stainless 304	Plain	Glued	5M	L11BGA
1 1/8"	Chisel	Stainless 304	Plain	Glued	5M	L14BGA

<sup>1</sup> Galvanized High Tensile, <sup>2</sup> Stainless 304 Steel High Tensile  
CS-Clamshell, \*Variety Pack

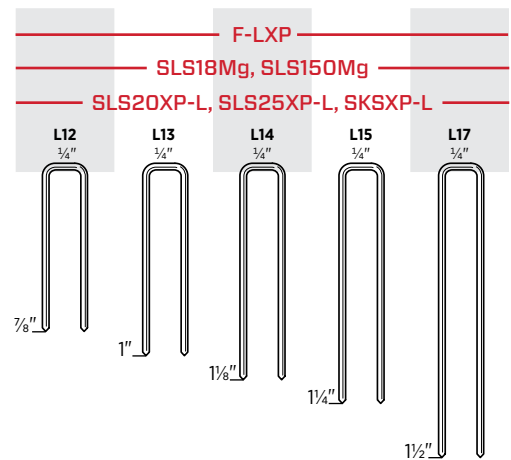
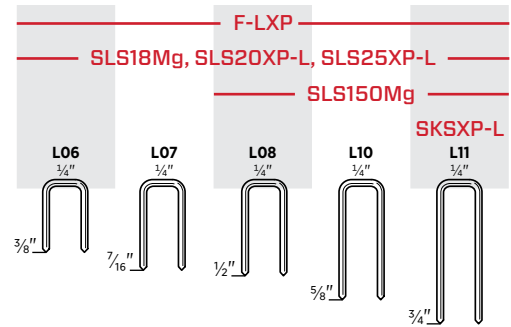



## 18<sup>GA</sup> 3/8" Crown Medium Wire Staples

Cabinets, casebacks, drawers, upholstery, soffits, underlayment, lattice and sheathing

Length	Point	Finish	Coating	Collation	Box Count	Item Code
5/8"	Chisel	Bright	Sencote	Glued	5M	M10BRBN
3/4"	Chisel	Bright	Sencote	Glued	5M	M11BRBN
1"	Chisel	Bright	Sencote	Glued	5M	M13BRB
3/8"	Chisel	Galv	Sencote	Glued	10M	M06BABN
1/2"	Chisel	Galv	Sencote	Glued	10M	M08BAB
5/8"	Chisel	Galv	Sencote	Glued	5M	M10BABN
3/4"	Chisel	Galv	Sencote	Glued	5M	M11BABN
7/8"	Chisel	Galv	Sencote	Glued	5M	M12BAB
1"	Chisel	Galv	Sencote	Glued	5M	M13BAB
1 1/4"	Chisel	Galv	Sencote	Glued	10M	M15BAB
1 1/2"	Chisel	Galv	Sencote	Glued	10M	M17BAB

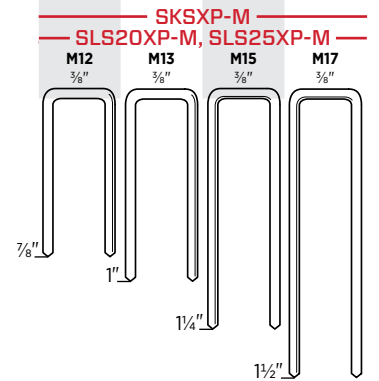
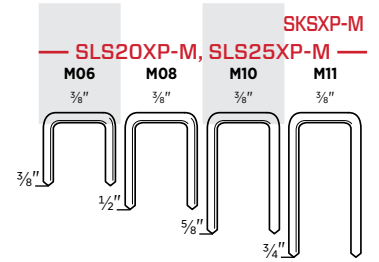

## 16<sup>GA</sup> 7/16" Crown Heavy Wire Staples

Cabinets, casebacks, drawers, upholstery, soffits, underlayment, lattice and sheathing

Length	Point	Finish	Coating	Collation	Box Count	Item Code
3/4"	Chisel	Bright	Sencote	Glued	5M	N11BRB
1"	Chisel	Bright	Sencote	Glued	5M	N13BRB
1 1/8"	Chisel	Bright	Sencote	Taped	10M	N14BRB
1 1/4"	Chisel	Bright	Sencote	Taped	10M	N15BRB
1 3/8"	Chisel	Bright	Sencote	Taped	10M	N16BRB
1 1/2"	Chisel	Bright	Sencote	Taped	10M	N17BRB
1 5/8"	Chisel	Bright	Sencote	Taped	10M	N18BRB
1 3/4"	Chisel	Bright	Sencote	Taped	10M	N19BRB
2"	Chisel	Bright	Sencote	Taped	10M	N21BRB
1/2"	Chisel	Galv	Sencote	Taped	5M	N08BABN
1/2"	Chisel	Galv*	Sencote	Glued	5M	N08BBBN
1/2"	Diverg	Galv*	Sencote	Glued	5M	N08FBB
5/8"	Chisel	Galv	Sencote	Glued	5M	N10BAB
3/4"	Chisel	Galv	Sencote	Glued	5M	N11BAB
3/4"	Diverg	Galv*	Sencote	Glued	5M	N11FBB
7/8"	Chisel	Galv	Sencote	Glued	5M	N12BABN
7/8"	Diverg	Galv	Sencote	Glued	5M	N12FABN
1"	Chisel	Galv	Sencote	Glued	5M	N13BAB
1"	Diverg	Galv	Sencote	Glued	5M	N13FAB
1 1/8"	Chisel	Galv	Sencote	Taped	10M	N14BAB
1 1/4"	Chisel	Galv	Sencote	Taped	10M	N15BAB
1 1/4"	Diverg	Galv	Sencote	Glued	10M	N15FAB
1 3/8"	Chisel	Galv	Sencote	Taped	10M	N16BAB
1 1/2"	Chisel	Galv	Sencote	Taped	10M	N17BAB
1 5/8"	Chisel	Galv	Sencote	Taped	10M	N18BAB
1 3/4"	Chisel	Galv	Sencote	Taped	10M	N19BAB
2"	Chisel	Galv	Sencote	Taped	10M	N21BAB
1 1/4"	Chisel	Stainless 304	Sencote	Glued	3M	N15BGB
1 1/2"	Chisel	Stainless 304	Sencote	Glued	3M	N17BGB
1 3/4"	Chisel	Stainless 304	Sencote	Glued	3M	N19BGBN
2"	Chisel	Stainless 304	Sencote	Glued	3M	N21BGBN

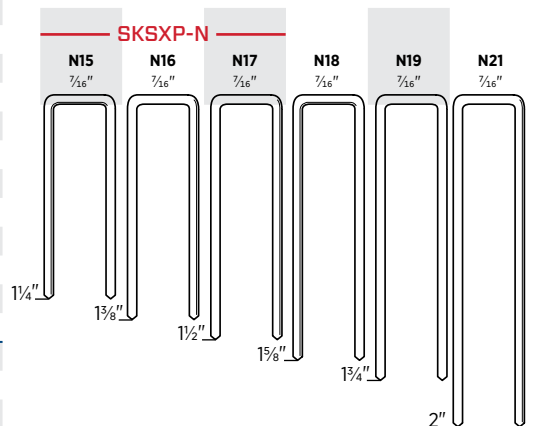
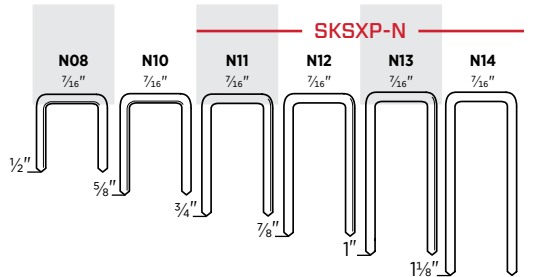

\*Galvanized High Tensile

25<sup>GA</sup>

## Sencor® 1" Crown Corrugated Fastener

Butt and miter joints

Length	Point	Finish	Coating	Collation	Box Count	Item Code
¼"	Sharp Chisel	Bright	Plain	Glued	8M	X04NRA
⅜"	Sharp Chisel	Bright	Plain	Glued	5M	X06NRA
½"	Sharp Chisel	Bright	Plain	Glued	4M	X08NRA

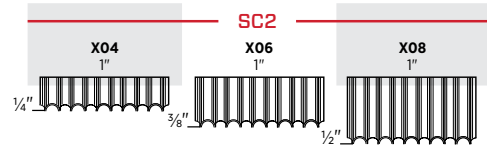

## SENCOR® CORRUGATED FASTENERS

Sencor corrugated fasteners provide twice the joint strength of ordinary fasteners. Available in 1" crown and ¼", ⅜" and ½" lengths to ensure maximum joint strength. Use this fastener for butt and miter joints, truss construction, wooden boxes, pallet repair, cabinet and furniture frames.

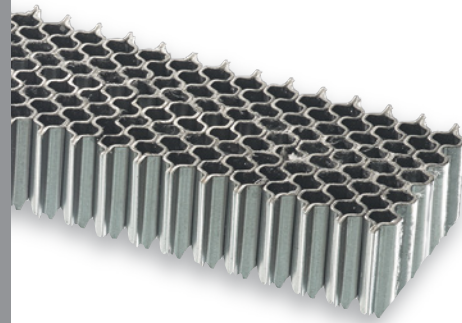

25<sup>GA</sup>

## Senclamp® 7/16" Crown Joint Fastener

Butt and miter joints

Length	Point	Finish	Coating	Collation	Box Count	Item Code
5/16"	Chisel	Bright	Plain	Taped	3M	Y05BFA
7/16"	Chisel	Bright	Plain	Taped	3M	Y07BFA
9/16"	Chisel	Bright	Plain	Taped	3M	Y09BFA

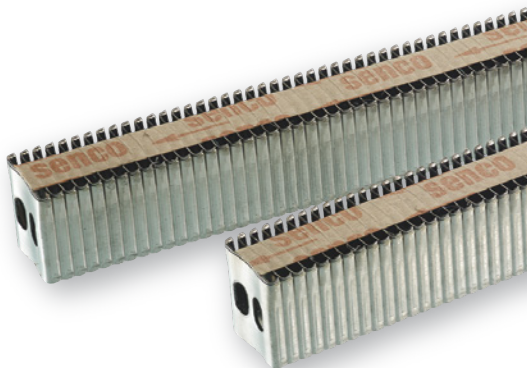
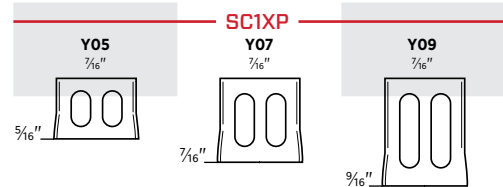

## SENCLAMP® JOINT FASTENERS

Senclamp has a special webbed design that draws the material together as it drives through it. Made from carbon steel, fasteners are available in 7/16" crown and 5/16", 7/16" and 9/16" lengths to best suit your requirements. Designed for a wide range of joint fastening applications, Senclamp secures joints better, faster and for less.

# FRAMING, SHEATHING & SUBFLOOR

## NAILING THE RIGHT BALANCE OF SIZE, WEIGHT AND POWER

We offer a large selection of pneumatic and cordless nailers for a wide variety of applications.

### APPLICATIONS

Framing, sheathing, truss building, installing subflooring, decking or fencing, assembling boxes or making pallets

### KEY FEATURES

- Low profile designs allow for easy access between studs and joists
- Highly efficient internal design for increased durability
- Dry fire lock out prevents dry firing and signals user when to reload
- Claw-like safety for precise toe-nailing





## F-35XP

CORDLESS PNEUMATIC FRAMING NAILER

ITEM #10G0001N



34°

### Features

- Fusion cordless air-power technology
- Pressure relief valve & refillable air port
- Brushless motor
- Includes 2 extended life batteries, quick charge battery charger and storage bag

## F-35FRHXP

CORDLESS PNEUMATIC FRAMING NAILER

ITEM #10H0001N



20°

### Features

- Fusion cordless air-power technology
- Pressure relief valve & refillable air port
- Brushless motor
- Includes 2 extended life batteries, quick charge battery charger and storage bag

## Battery Platform

### SENCO'S 18-Volt Li-Ion Battery System

Designed for long running times with quick recharges, the battery operates at full speed until depleted, so there is no gradual drop in power during use. Special LED fuel gauge displays battery life at the touch of a button. See the complete SENCO battery platform in the accessories section on page 77.



18V Li-Ion Battery 3.0 amp hour	Fits
VB0190	F-35XP F-35FRHXP
Battery Charger	For use with
VB0189	VB0190



## Product Reference Chart

TOOL SPECS	F-35XP	F-35FRHXP
<b>Trigger</b>	Selectable	Selectable
<b>Technology</b>	Fusion	Fusion
<b>Power Type</b>	Cordless	Cordless
<b>Battery</b>	3.0Ah / 54Wh	3.0Ah / 54Wh
<b>Weight (with Battery)</b>	11.37 lbs (5.16 kg)	11.38 lbs (5.17 kg)
<b>Height</b>	14.4" (366 mm)	14.4" (366 mm)
<b>Length</b>	14.0" (356 mm)	14.6" (371 mm)
<b>Width</b>	5.5" (140 mm)	4.7" (119 mm)
<b>Charge Time</b>	80% in 30 minutes, 100% in 60 minutes.	
<b>Warranty</b>	5 yrs	5 yrs
FASTENER SPECS	Fasteners are located on pages 39-42	
<b>Range</b>	2"-3½"	2"-3½"
<b>Shank</b>	.113"-.148"	.113"-.131"
<b>Capacity</b>	60	35
<b>Angle/Collation</b>	30-34° Angled Paper Tape Strip	20-21° Angled Plastic Strip
<b>Series</b>	GC, GE, HC, HE, HF, KC ProHead G5, G6, H5, H6, K5, K6	GD, GL, HD, HL, KD, MD
TOOL FEATURES		
<b>Depth-of-Drive</b>	Yes, Tool-Free	Yes, Tool-Free
<b>Rafter Hook</b>	Yes	Yes
<b>Dry Fire Lockout</b>	Yes	Yes



## FN91T1

3½" PAPER TAPE FRAMING NAILER

34°



COMING SOON

### Features

- Best in class tool power & durability
- Well-balanced ergonomic design
- In-line magazine for optimal line of sight
- Aggressive toenail safety
- Tool-free depth of drive
- Engineered and Assembled in Cincinnati, Ohio

## FN81T1

3½" FULL ROUND HEAD FRAMING NAILER

20°



COMING SOON

### Features

- Best in class tool power & durability
- Well-balanced ergonomic design
- In-line magazine for optimal line of sight
- Aggressive toenail safety
- Tool-free depth of drive
- Engineered and Assembled in Cincinnati, Ohio

## The New Standard in Framing

The FN81T1 and FN91T1 deliver the power and durability demanded by professional contractors for all-day performance on the toughest jobsites. Upgraded features include an ergonomic design, an in-line magazine for clear line of sight, and a tool-free depth of drive for quick adjustments.



## Product Reference Chart

TOOL SPECS	FN91T1	FN81T1
<b>Trigger</b>	Sequential	Sequential
<b>Operating Pressure</b>	70-120 psi (4.8-8.3 bar)	70-120 psi (4.8-8.3 bar)
<b>Air Consumption</b> (60 CPM)	6.7 scfm	6.7 scfm
<b>Air Inlet</b>	¾" NPT	¾" NPT
<b>Weight</b>	8.39 lbs (3.8 kg)	8.75 lbs (3.9 kgs)
<b>Height</b>	14.13" (358 mm)	14.13" (358 mm)
<b>Length</b>	17.25" (438 mm)	20.75" (527 mm)
<b>Width</b>	4.88" (123 mm)	4.88" (123 mm)
<b>Main Body Material</b>	Aluminum	Aluminum
<b>Warranty</b>	5 yrs	5 yrs
<b>FASTENER SPECS</b>	Fasteners are located on pages 39-40	
<b>Range</b>	2" or 3½"	2" or 3½"
<b>Shank</b>	.113"-.135"	.113"-.148"
<b>Capacity</b>	80	70
<b>Angle/Collation</b>	30-34° Angled Paper Tape Strip	20-21° Angled Plastic Strip
<b>Series</b>	ProHead G5, H5, K5, G6, H6, K6 Clipped Head GC, GE, HC, HE, HF, KC, LC	GD, HD, KD, MD, GL, HL
<b>TOOL FEATURES</b>		
<b>Depth-of-Drive</b>	Yes, Tool-Free	Yes, Tool-Free
<b>Rafter Hook</b>	Yes	Yes
<b>Dry Fire Lockout</b>	Yes	Yes

## FramePro®325XP

3/4" PAPER TAPE FRAMING NAILER

ITEM #4Z0101N



34°

### Features

- Patented TrueDrive magazine reduces jams and misfeeds
- Efficient internal design means less wear and tear on the compressor
- Claw-like toenail safety
- Fits easily between studs and joists

## FramePro®701XP

3/2" PAPER TAPE FRAMING NAILER

ITEM #2H0133N



34°

### Features

- In-line magazine for optimal line of sight
- Simple two-step loading
- Claw-like toenail safety
- Fits easily between studs and joists

## FramePro®751XP

3/2" PAPER TAPE FRAMING NAILER

ITEM #2J0103N



34°

### Features

- In-line magazine for optimal line of sight
- Simple two-step loading
- Claw-like toenail safety
- Fits easily between studs and joists

## Magazine Retrofit Kit (Sold Separately)

Updated magazine options		
FITS TOOLS	DESCRIPTION	ITEM #
FramePro701XP	2-Nail Strip Magazine Retrofit Kit	YJ0055
FramePro701XP	Double Length Magazine Retrofit Kit	YJ0043
FramePro751XP	4" Nail Feed System Retrofit Kit	YJ0042

## Product Reference Chart

TOOL SPECS	FramePro®325XP	FramePro®701XP	FramePro®751XP
<b>Trigger</b>	Selectable	Sequential	Sequential
<b>Operating Pressure</b>	70-120 psi (4.8-8.3 bar)	70-120 psi (4.8-8.3 bar)	70-120 psi (4.8-8.3 bar)
<b>Air Consumption</b> (60 CPM)	5.2 scfm	10 scfm	11 scfm
<b>Air Inlet</b>	3/8" NPT	3/8" NPT	3/8" NPT
<b>Weight</b>	7.9 lbs (3.58 kg)	8 lbs (3.62 kg)	8.4 lbs (3.8 kg)
<b>Height</b>	11.9" (302 mm)	13.25" (337 mm)	14.25" (362 mm)
<b>Length</b>	17.3" (440 mm)	15.13" (384 mm)	15.13" (384 mm)
<b>Width</b>	4.5" (114 mm)	4.17" (106 mm)	4.17" (106 mm)
<b>Main Body Material</b>	Aluminum	Aluminum	Aluminum
<b>Warranty</b>	5 yrs	5 yrs	5 yrs
<b>FASTENER SPECS</b>	Fasteners are located on pages 39-40		
<b>Range</b>	2"-3 1/4"	2"-3 1/2"	2"-3 1/2"
<b>Shank</b>	.113"-.148"	.113"-.135"	.113"-.148"
<b>Capacity</b>	83	70	70
<b>Angle/Collation</b>	30-34° Angled Paper Tape Strip	30-34° Angled Paper Tape Strip	30-34° Angled Paper Tape Strip
<b>Series</b>	GC, GE, HC, HE, HF, KC ProHead G5, G6, H5, H6, K5, K6	GC, GE, HC, HE, HF, KC ProHead G5, G6, H5, H6, K5, K6	GC, GE, HC, HE, HF, KC, LC ProHead G5, G6, H5, H6, K5, K6
<b>TOOL FEATURES</b>			
<b>Depth-of-Drive</b>	Yes, Tool-Free	Yes, Tool-Free	Yes, Tool-Free
<b>Rafter Hook</b>	Yes	Yes	Yes
<b>Dry Fire Lockout</b>	Yes	Yes	Yes

## FramePro®325FRHXP

3¼" FULL ROUND HEAD FRAMING NAILER

ITEM #4H0101N

20°



### Features

- Patented TrueDrive magazine reduces jams and misfeeds
- Effective internal design means less wear and tear on the compressor
- Claw-like toenail safety
- Fits easily between studs and joists

## FramePro®752XP

3½" FULL ROUND HEAD FRAMING NAILER

ITEM #2F0103N

20°



### Features

- 20° in-line magazine provides excellent maneuverability and line of sight
- Simple two-step loading
- Claw-like toenail safety
- Fits easily between studs and joists

## FramePro®702XP

3½" FULL ROUND HEAD FRAMING NAILER

ITEM #2K0103N

20°

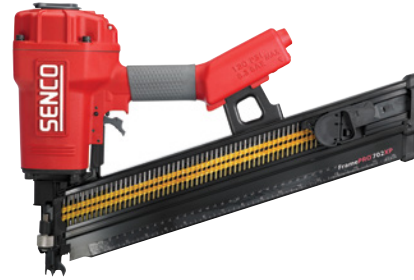

### Features

- 20° in-line magazine provides excellent maneuverability and line of sight
- Simple two-step loading
- Claw-like toenail safety
- Fits easily between studs and joists

## Product Reference Chart

TOOL SPECS	FramePro®325FRHXP	FramePro®702XP	FramePro®752XP
<b>Trigger</b>	Selectable	Sequential	Sequential
<b>Operating Pressure</b>	70-120 psi (4.8-8.3 bar)	70-120 psi (4.8-8.3 bar)	70-120 psi (4.8-8.3 bar)
<b>Air Consumption</b> (60 CPM)	5.2 scfm	10 scfm	11 scfm
<b>Air Inlet</b>	¾" NPT	¾" NPT	¾" NPT
<b>Weight</b>	7.9 lbs (3.58 kg)	8.4 lbs (3.8 kg)	8.7 lbs (3.97 kg)
<b>Height</b>	11.9" (302 mm)	13.25" (337 mm)	14.25" (362 mm)
<b>Length</b>	17.3" (440 mm)	20" (508 mm)	20" (508 mm)
<b>Width</b>	4.5" (114 mm)	4.17" (106 mm)	4.17" (106 mm)
<b>Main Body Material</b>	Aluminum	Aluminum	Aluminum
<b>Warranty</b>	5 yrs	5 yrs	5 yrs
<b>FASTENER SPECS</b>	Fasteners are located on page 41-42		
<b>Range</b>	2"-3¼"	2"-3½"	2"-3½"
<b>Shank</b>	.113"-.148"	.113"-.148"	.120"-.162"
<b>Capacity</b>	64	60	60
<b>Angle/Collation</b>	20-21° Angled Plastic Strip	20-21° Angled Plastic Strip	20-21° Angled Plastic Strip
<b>Series</b>	GD, GL, HD, HL, HK, KD, KL, MD	GD, GL, HD, HL, KD, MD	GD, GL, HD, HL, KD, MD
<b>TOOL FEATURES</b>			
<b>Depth-of-Drive</b>	Yes, Tool-Free	Yes- Tool Free	Yes, Tool-Free
<b>Rafter Hook</b>	Yes	Yes	Yes
<b>Dry Fire Lockout</b>	Yes	Yes	Yes

## SCN60XP

2¾" COIL NAILER

ITEM #520101N



15°

### Features

- High load capacity
- EZ-Load design saves time
- Fast cycle time increases productivity
- Lightweight for comfortable all-day use

## Mini Hand Nailer

2"-3½" BULK NAILER

ITEM #PC1195



### Features

- Compact and powerful enough to drive 2"-3½" bulk nails
- Magnetic nose holds nail in place for safe, accurate placement
- Ultra-light at just 1 pound

## SCN65XP

3½" COIL NAILER

ITEM #540101N - FLAT SAFETY; 540104N - TOENAIL SAFETY



15°

### Features

- High load capacity
- EZ-Load design saves time
- Fast cycle time increases productivity
- Light and fast for greater productivity

## A20 Hand Nailer

2"-7" BULK NAILER

ITEM #PC0781



### Features

- Drives bulk nails from 2"-7"
- Soft rubber palm pad for comfortable grip
- Magnetic nose holds nail in place for safe, accurate placement
- Includes leather strap for comfort

## Product Reference Chart

TOOL SPECS	SCN60XP	SCN65XP	Mini Hand Nailer	A20 Hand Nailer
<b>Trigger</b>	Contact	Contact	—	—
<b>Operating Pressure</b>	70-120 psi (4.8-8.3 bar)	70-120 psi (4.8-8.3 bar)	60-110 psi (4-7.6 bar)	50-125 psi (3.5-8.4 bar)
<b>Air Consumption</b> (60 CPM)	8.29 scfm	9.54 scfm	2-4 scfm	2-4 scfm
<b>Air Inlet</b>	¾" NPT	¾" NPT	¼" NPT	¾" NPT
<b>Weight</b>	7.5 lbs (3.4 kg)	8 lbs (3.6 kg)	1 lb (.45 kg)	2.4 lbs (1.1 kg)
<b>Height</b>	12.38" (314 mm)	14.1" (359 mm)	4" (101 mm)	5.8" (122 mm)
<b>Length</b>	12.88" (327 mm)	12.88" (327 mm)	2.75" (70 mm)	4" (101 mm)
<b>Width</b>	5.38" (137 mm)	5.38" (137 mm)	2" (55.6 mm)	3.25" (83 mm)
<b>Main Body Material</b>	Aluminum	Aluminum	Aluminum	Aluminum
<b>Warranty</b>	5 yrs	5 yrs	1 yr	1 yr
<b>FASTENER SPECS</b>	Fasteners are located on pages 42-44			
<b>Range</b>	2"-2¾"	2"-3½"	Bulk nails from 2"-3½"	Bulk nails from 2"-3½" up to 7" with opt. guide tips
<b>Shank</b>	.099"-.113"	.099"-.131"	—	.113"-.148"
<b>Capacity</b>	250-275	225-275	1	1
<b>Angle/Collation</b>	15° Flat Wire Welded Coil	15° Flat Wire Welded Coil	—	—
<b>Series</b>	BK, BL, BT, GD, GL, HR	BJ, BK, BL, BT, GD, GL, HD, HK, HL, KD	—	—
<b>TOOL FEATURES</b>				
<b>Depth-of-Drive</b>	Yes, Tool-Free	Yes, Tool-Free	—	—
<b>Rafter Hook</b>	No	No	—	—
<b>Dry Fire Lockout</b>	No	No	—	—



## JN91H1

1½" METAL CONNECTOR NAILER



34°

### Features

- Lightweight and well-balanced for comfortable all day use
- Power to drive through engineered lumber
- Leads with the nail to locate metal connector holes, providing accurate nail placement
- Dry fire lockout reduces tool wear and indicates the need to reload fasteners

## JN91H2

1½" METAL CONNECTOR NAILER



34°

### Features

- Extended magazine holds two racks of nails
- Lightweight and well-balanced for comfortable all day use
- Power to drive through engineered lumber
- Leads with the nail to locate metal connector holes, providing accurate nail placement
- Dry fire lockout reduces tool wear and indicates the need to reload fasteners

## JN91P1

1½"-2½" METAL CONNECTOR NAILER



34°

COMING SOON

### Features

- Lightweight and well-balanced for comfortable all day use
- Power to drive through engineered lumber
- Nosepiece probe locates metal connector holes, providing accurate nail placement
- Dry fire lockout reduces tool wear and indicates the need to reload fasteners

## JN91P2

1½"-2½" METAL CONNECTOR NAILER



34°

COMING SOON

### Features

- Extended magazine holds two racks of nails
- Lightweight and well-balanced for comfortable all day use
- Power to drive through engineered lumber
- Nosepiece probe locates metal connector holes, providing accurate nail placement
- Dry fire lockout reduces tool wear and indicates the need to reload fasteners

## Product Reference Chart

TOOL SPECS	JN91H1	JN91H2	JN91P1	JN91P2
<b>Trigger</b>	Sequential	Sequential	Sequential	Sequential
<b>Operating Pressure</b>	70-120 psi (4.8-8.3 bar)	70-120 psi (4.8 - 8.3 bar)	70-120 psi (4.8-8.3 bar)	70-120 psi (4.8 - 8.3 bar)
<b>Air Consumption</b> (60 CPM)	4.4 scfm	4.4 scfm	6.4 scfm	6.4 scfm
<b>Air Inlet</b>	¼" NPT	¼" NPT	¼" NPT	¼" NPT
<b>Weight</b>	5.48 lbs (2.48 kg)	5.8 lbs (2.63 kg)	7.53 lbs (3.41 kg)	7.92 lbs (3.59 kg)
<b>Height</b>	12.5" (317 mm)	12.5" (317 mm)	14.38" (365 mm)	14.38" (365 mm)
<b>Length</b>	11.13" (282 mm)	17.86" (453 mm)	14" (355 mm)	19" (482 mm)
<b>Width</b>	4.38" (111 mm)	4.88" (123 mm)	5.25" (133 mm)	6.13" (155 mm)
<b>Main Body Material</b>	Magnesium	Magnesium	Magnesium	Magnesium
<b>Warranty</b>	5 yrs	5 yrs	5 yrs	5 yrs
<b>FASTENER SPECS</b>	Fasteners are located on page 45			
<b>Range</b>	1½"	1½"	1½"-2½"	1½"-2½"
<b>Shank</b>	.131"-.148"	.131"-.148"	.131"-.162"	.131"-.162"
<b>Capacity</b>	30	55	35	55
<b>Angle/Collation</b>	34° Paper Tape Strip	34° Paper Tape Strip	34° Paper Tape Strip	34° Paper Tape Strip
<b>Series</b>	KJ, MD	KJ, MD	KJ, MD, ND	KJ, MD, ND
<b>TOOL FEATURES</b>				
<b>Depth-of-Drive</b>	No	No	Yes	Yes
<b>Rafter Hook</b>	Yes	Yes	Yes	Yes
<b>Dry Fire Lockout</b>	Yes	Yes	Yes	Yes

## SCP40XP

1½" STANDARD PRESSURE PNEUMATIC CONCRETE & STEEL PINNER

ITEM #7J0001N



0°

### Features

- 10 times faster than powder-actuated systems
- No licensing required to operate
- Works with conventional air compressors, hoses and fittings
- Operates at extreme temperatures and altitudes

## PS20XP

1" WIDE CROWN, 2" HEAVY WIRE STAPLER

ITEM #9W0001N



16<sub>GA</sub>

### Features

- Enhanced EZ-Clear™ latch allows for quick access to clear fasteners
- Updated aggressive locking feature provides superior holding power for complete control of the fastener, offering pinpoint accuracy and unrivaled driveability
- New drive track design eliminates movement of the staple, enhancing overall drive performance and virtually eliminating fastener jams, skipping and misfires

## PS15XP

1" WIDE CROWN, 1½" HEAVY WIRE STAPLER

ITEM #9T0001N



16<sub>GA</sub>

### Features

- Enhanced EZ-Clear™ latch allows for quick access to clear fasteners and a new locking feature offers pinpoint accuracy and unrivaled driveability
- Updated drive track eliminates staple movement, virtually eliminating jams
- Robust firing valve design makes the tool fast, powerful and efficient
- Positive-locking adjustable depth-of-drive ensures consistently flush drives

## Concrete Pinner

### Plaster, stucco & building wrap fastening attachment

	Fits Tools	Range	ITEM #	
SENCO	SCP40XP	1¼"	NPC035	 Magnetic washer nosepiece

### Galvanized Metal Washer

ITEM #	Diameter	Box Count	Fits SCP40XP, GT40CP
SWM125B	1¼"	1M	.109" Dia. Concrete Pins



## Feed System Retrofit Kit (Sold Separately)

### Updated feed system option

CONVERTS	ITEM #
WC150 to PS15XP	YJ0044

## Product Reference Chart

TOOL SPECS	SCP40XP	PS15XP	PS20XP
<b>Trigger</b>	Selectable	Contact	Contact
<b>Operating Pressure</b>	80-120 psi (5.5-8.3 bar)	70-120 psi (4.8-8.3 bar)	70-120 psi (4.8-8.3 bar)
<b>Air Consumption</b> (60 CPM)	5.2 scfm	3.18 scfm	3.45 scfm
<b>Air Inlet</b>	¾" NPT	¾" NPT	¾" NPT
<b>Weight</b>	7.1 lbs (3.2 kg)	5.5 lbs (2.5 kg)	5.5 lbs (2.5 kg)
<b>Height</b>	12.22" (310 mm)	9" (229 mm)	10" (254 mm)
<b>Length</b>	18.2" (462 mm)	15.25" (387 mm)	15.25" (387 mm)
<b>Width</b>	4.5" (114.4 mm)	5.5 lbs (2.5 kg)	3.5" (89 mm)
<b>Main Body Material</b>	Aluminum	Aluminum	Aluminum
<b>Warranty</b>	5 yrs	5 yrs	5 yrs
<b>FASTENER SPECS</b>	Fasteners are located on pages 45-47		
<b>Shank/Crown</b>	.109"/.118" Shanks	1" Crown	1" Crown
<b>Range</b>	½"-1½"	⅝"-1½"	⅞"-2"
<b>Capacity</b>	42	160	160
<b>Angle/Collation</b>	Straight Plastic Collated Strip	Taped and taped glued	Straight Glued and Taped Strip
<b>Series</b>	W3	P	P
<b>TOOL FEATURES</b>			
<b>Depth-of-Drive</b>	No	Yes, Tool-Free	Yes, Tool-Free
<b>Belt Hook</b>	No	Yes	Yes
<b>Dry Fire Lockout</b>	Yes	No	No

## NS20XP

7/16" CROWN, 2" HEAVY WIRE STAPLER

ITEM #9X0001N

17<sub>GA</sub> 16<sub>GA</sub>



### Features

- 15% more powerful than all other construction staplers in its class
- Enhanced EZ-Clear™ latch allows for quick access to clear fasteners
- Updated aggressive locking feature
- Drive track design eliminates movement of the staple
- Can also be used for vinyl siding installation (item number HC0788 required, sold separately)

## SNS41

7/16" CROWN, 2" HEAVY WIRE STAPLER

ITEM #3L0003N

17<sub>GA</sub> 16<sub>GA</sub>



### Features

- Durable construction minimizes downtime and operating costs
- EZ-Clear™ latch virtually eliminates downtime caused by fastener jams
- Fast, multidirectional stitching

## NS20BXP

7/16" CROWN, HEAVY WIRE STAPLER

ITEM #9Y0001N

17<sub>GA</sub> 16<sub>GA</sub>



### Features

- 20% more powerful than the standard NS20XP for the most demanding applications
- Enhanced EZ-Clear™ latch allows for quick access to clear fasteners
- Updated aggressive locking feature
- Can also be used for vinyl siding installation (item number HC0788 required, sold separately)

## SQS55XP

7/16" CROWN, 2 1/2" HEAVY WIRE STAPLER

ITEM #660101N

15<sub>GA</sub>



### Features

- Fast — up to 15 staples per second
- EZ-Clear™ latch virtually eliminates downtime caused by fastener jams
- Rugged dependability

## Product Reference Chart

TOOL SPECS	NS20XP	NS20BXP	SNS41	SQS55XP
<b>Trigger</b>	Contact	Contact	Contact	Contact
<b>Operating Pressure</b>	70–120 psi (4.8–8.3 bar)	70–120 psi (4.8–8.3 bar)	80–120 psi (5.5–8.3 bar)	80–120 psi (5.5–8.3 bar)
<b>Air Consumption</b> (60 CPM)	3.5 scfm	3.98 scfm	5.4 scfm	6.54 scfm
<b>Air Inlet</b>	3/8" NPT	3/8" NPT	3/8" NPT	3/8" NPT
<b>Weight</b>	5.1 lbs (2.3 kg)	5.8 lbs (2.6 kg)	4.6 lbs (2.1 kg)	5.9 lbs (2.7 kg)
<b>Height</b>	11" (279 mm)	11" (279 mm)	10.75" (273 mm)	12" (305 mm)
<b>Length</b>	15" (381 mm)	15" (381 mm)	15" (381 mm)	14.38" (365 mm)
<b>Width</b>	3.5" (89 mm)	4" (102 mm)	3.4" (86 mm)	3.6" (92 mm)
<b>Main Body Material</b>	Aluminum	Aluminum	Aluminum	Aluminum
<b>Warranty</b>	5 yrs	5 yrs	5 yrs	5 yrs
<b>FASTENER SPECS</b>	Fasteners are located on pages 46–47			
<b>Crown</b>	7/16"	7/16"	7/16"	7/16"
<b>Range</b>	1"–2"	1"–2"	1"–2"	1 1/4"–2 1/2"
<b>Capacity</b>	160	160	160	130
<b>Angle/Collation</b>	Straight Glued and Taped Strip	Straight Glued and Taped Strip	Straight Glued and Taped Strip	Straight Glued and Taped Strip
<b>Series</b>	N, O	N, O	N, O	Q
<b>TOOL FEATURES</b>				
<b>Depth-of-Drive</b>	Yes, Tool-Free	Yes, Tool-Free	Yes, Tool-Required	Yes, Tool-Required
<b>Belt Hook</b>	Yes	Yes	No	No
<b>Dry Fire Lockout</b>	No	No	No	No

# FRAMING, SHEATHING & SUBFLOOR FASTENERS

## 34° ProHead® Smooth Paper Tape Nails

Framing, sheathing, subfloor, decks, trusses and pallets

Length	Point	Finish	Coating	Collation	Box Count	Item Code
2 3/8" x .113"	Diamond	Bright	Sencote	34° Paper Tape Strip	2.5M	G524APBXN
3" x .120"	Diamond	Bright	Sencote	34° Paper Tape Strip	2.5M	H527APBXN
3 1/4" x .120"	Diamond	Bright	Sencote	34° Paper Tape Strip	2.5M	H528APBXN
2 1/2" x .131"	Diamond	Bright	Sencote	34° Paper Tape Strip	2M	K525APBXN
3" x .131"	Diamond	Bright	Sencote	34° Paper Tape Strip	2.5M	K527APBXN
3" x .131"	Diamond	Bright	Sencote	34° Paper Tape Strip	0.5M	K527APBXR
3 1/4" x .131"	Diamond	Bright	Sencote	34° Paper Tape Strip	2.5M	K528APBXN
3 1/4" x .131"	Diamond	Bright	Sencote	34° Paper Tape Strip	0.5M	K528APBXR
3 1/2" x .131"	Diamond	Bright	Sencote	34° Paper Tape Strip	2.5M	K529APBXN
2 3/8" x .113"	Diamond	Hot Dip	Sencote	34° Paper Tape Strip	2.5M	G524ASBXN
3" x .131"	Diamond	Hot Dip	Sencote	34° Paper Tape Strip	2.5M	K527ASBXN
3 1/4" x .131"	Diamond	Hot Dip	Sencote	34° Paper Tape Strip	2.5M	K528ASBXN

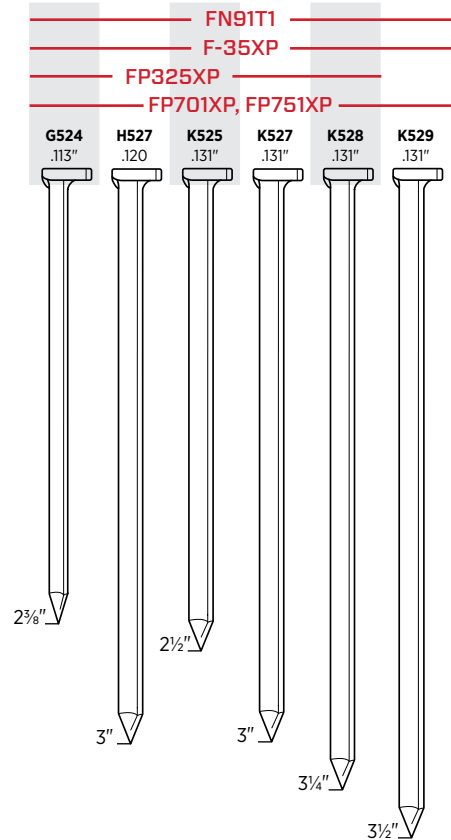

## 34° ProHead® Ring Paper Tape Nails

Framing, sheathing, subfloor, decks, trusses and pallets

Length	Point	Finish	Coating	Collation	Box Count	Item Code
2 3/8" x .113"	Diamond	Bright	Sencote	34° Paper Tape Strip	2.5M	G624APBXN
3" x .120"	Diamond	Bright	Sencote	34° Paper Tape Strip	2.5M	H627APBXN
3 1/4" x .131"	Diamond	Bright	Sencote	34° Paper Tape Strip	2.5M	K628APBXN
2" x .113"	Diamond	Hot Dip	Sencote	34° Paper Tape Strip	2.5M	G621ASBXN
2 3/8" x .113"	Diamond	Hot Dip	Sencote	34° Paper Tape Strip	2.5M	G624ASBXN
3" x .120"	Diamond	Hot Dip	Sencote	34° Paper Tape Strip	2.5M	H627ASBXN
3" x .131"	Diamond	Hot Dip	Sencote	34° Paper Tape Strip	2.5M	K627ASBXN
3 1/4" x .131"	Diamond	Hot Dip	Sencote	34° Paper Tape Strip	2.5M	K628ASBXN
3 1/2" x .131"	Diamond	Hot Dip	Sencote	34° Paper Tape Strip	2.5M	K629ASBXN

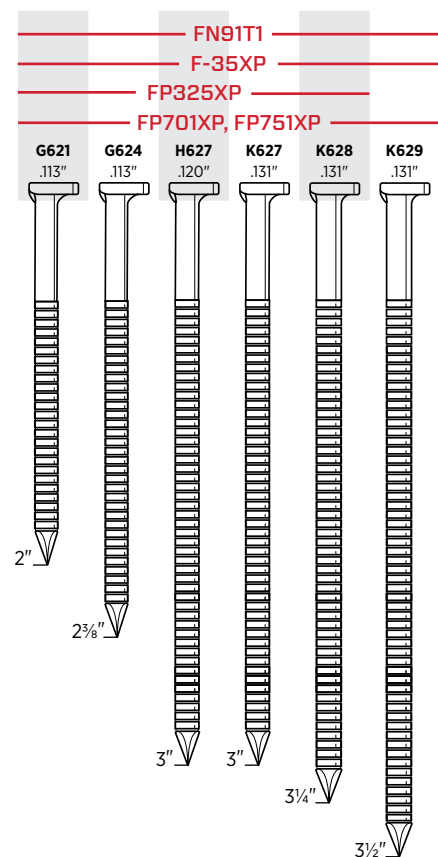



# FRAMING, SHEATHING & SUBFLOOR FASTENERS

## 34° Smooth Shank Paper Tape Collated Nails

Framing, sheathing, subfloor, decks, trusses and pallets						
Length	Point	Finish	Coating	Collation	Box Count	Item Code
2¼" x .113"	Diamond	Bt. Hardened	Plain	34° Paper Tape Strip	1M	GC23AHAK
2" x .113"	Diamond	Bright	Sencote	34° Paper Tape Strip	2.5M	GC21APBX
2¾" x .113"	Diamond	Bright	Sencote	34° Paper Tape Strip	2.5M	GC24APBX
2½" x .113"	Diamond	Bright	Sencote	34° Paper Tape Strip	2.5M	GC25APBX
3" x .120"	Diamond	Bright	Sencote	34° Paper Tape Strip	2.5M	HC27APBX
3¼" x .120"	Diamond	Bright	Sencote	34° Paper Tape Strip	2.5M	HC28APBX
3" x .131"	Diamond	Bright	Sencote	34° Paper Tape Strip	2.5M	KC27APBX
3¼" x .131"	Diamond	Bright	Sencote	34° Paper Tape Strip	2.5M	KC28APBX
3½" x .131"	Diamond	Bright	Sencote	34° Paper Tape Strip	2.5M	KC29APBX
3½" x .135"	Diamond	Bright	Sencote	34° Paper Tape Strip	2.5M	LC29APBX
4" x .131"	Diamond	Bright	Sencote	34° Paper Tape Strip	2.5M	KC31APBX*
2¾" x .113"	Diamond	Hot Dip	Sencote	34° Paper Tape Strip	2.5M	GC24ASBX
3" x .120"	Diamond	Hot Dip	Sencote	34° Paper Tape Strip	2.5M	HC27ASBX
3" x .131"	Diamond	Hot Dip	Sencote	34° Paper Tape Strip	2.5M	KC27ASBX
3¼" x .131"	Diamond	Hot Dip	Sencote	34° Paper Tape Strip	2.5M	KC28ASBX
3½" x .131"	Diamond	Hot Dip	Sencote	34° Paper Tape Strip	2.5M	KC29ASBX
3" x .131"	Diamond	Stainless 304	Sencote	34° Paper Tape Strip	1M	KC27AGBK
3¼" x .131"	Diamond	Stainless 304	Sencote	34° Paper Tape Strip	1M	KC28AGBK

\*FramePro®751XP can drive 4 inch nails when fitted with the YJ0042 kit

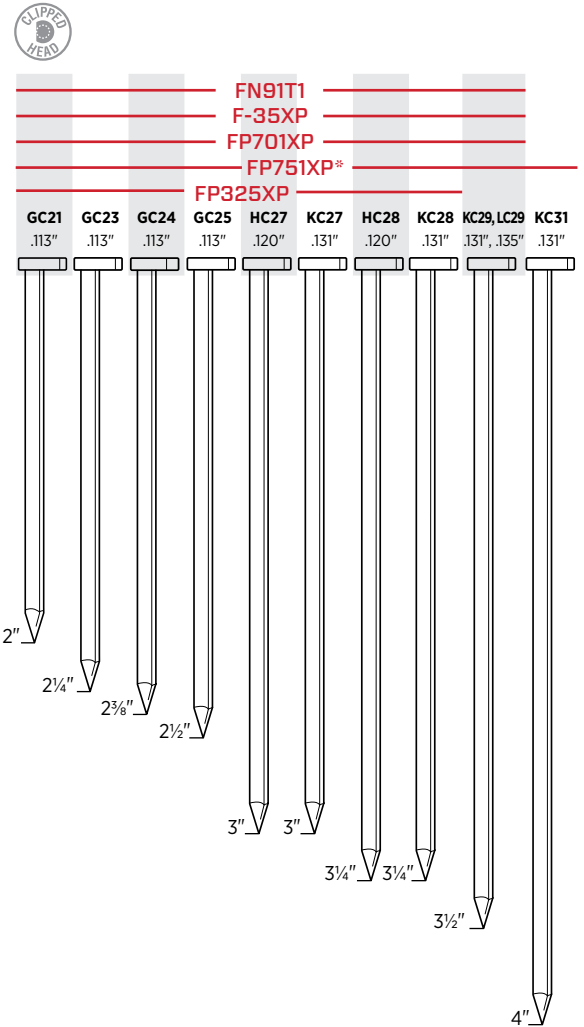

## 34° Ring Shank Paper Tape Collated Nails

Framing, sheathing, subfloor, decks, trusses and pallets						
Length	Point	Finish	Coating	Collation	Box Count	Item Code
2" x .113"	Diamond	Bright	Plain	34° Paper Tape Strip	2.5M	GE21APAX
2¾" x .113"	Diamond	Bright	Sencote	34° Paper Tape Strip	2.5M	GE24APBX
2" x .113"	Diamond	Hot Dip	Sencote	34° Paper Tape Strip	2.5M	GE21ASBX
2¾" x .113"	Diamond	Hot Dip	Sencote	34° Paper Tape Strip	2.5M	GE24ASBX
3" x .120"	Diamond	Hot Dip	Sencote	34° Paper Tape Strip	2.5M	HE27ASBX
2¾" x .113"	Diamond	Stainless 304	Sencote	34° Paper Tape Strip	1M	GE24AGBK

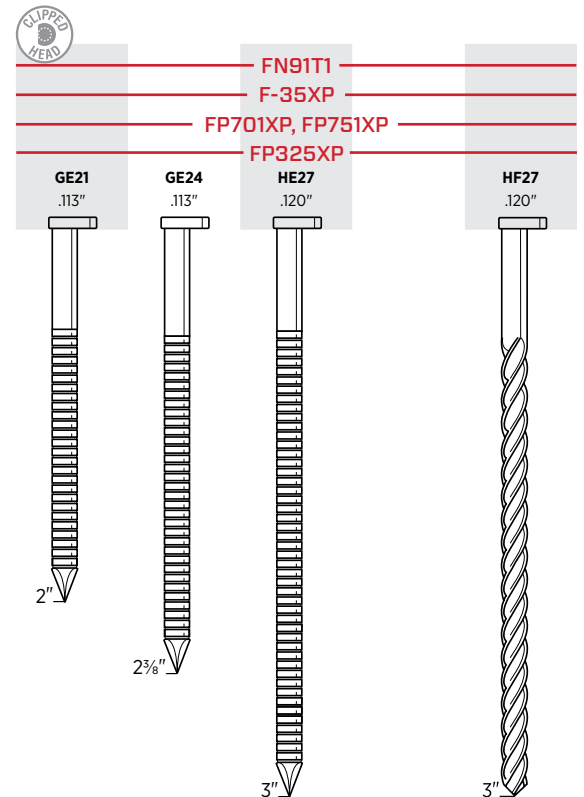

## 34° Screw Shank Paper Tape Collated Nails

Framing, sheathing, subfloor, decks, trusses and pallets						
Length	Point	Finish	Coating	Collation	Box Count	Item Code
3" x .120"	Chisel	Bright	Plain	34° Paper Tape Strip	3.1M	HF27EPAK
3" x .120"	Chisel	Bright	Sencote	34° Paper Tape Strip	1M	HF27EDB

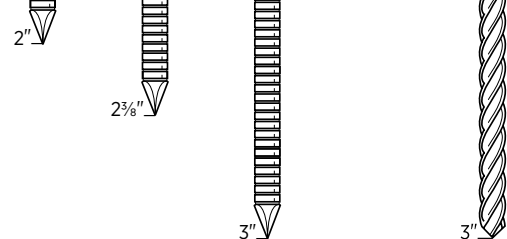

# FRAMING, SHEATHING & SUBFLOOR FASTENERS

## 20° Smooth Shank Plastic Collated Nails

Framing, sheathing, subfloor, decks, trusses and pallets						
Length	Point	Finish	Coating	Collation	Box Count	Item Code
2 3/8" x .113"	Diamond	Bright	Sencote	20° Plastic Strip	5M	GD24APBSN
2 1/2" x .113"	Diamond	Bright	Sencote	20° Plastic Strip	5M	GD25APBSN
2 1/2" x .131"	Diamond	Bright	Sencote	20° Plastic Strip	4M	KD25APBSN
3" x .120"	Diamond	Bright	Sencote	20° Plastic Strip	4M	HD27APBSN
3" x .131"	Diamond	Bright	Sencote	20° Plastic Strip	4M	KD27APBSN
3" x .148"	Diamond	Bright	Sencote	20° Plastic Strip	4M	MD27APBSN
3 1/4" x .131"	Diamond	Bright	Sencote	20° Plastic Strip	4M	KD28APBSN
3 1/4" x .148"	Diamond	Bright	Sencote	20° Plastic Strip	4M	MD28APBSN
3 1/2" x .131"	Diamond	Bright	Sencote	20° Plastic Strip	4M	KD29APBSN
2 3/8" x .113"	Diamond	Hot Dip	Sencote	20° Plastic Strip	2.5M	GD24ASBS
2 1/2" x .113"	Diamond	Galv	Sencote	20° Plastic Strip	5M	GD25AABS
2 1/2" x .120"	Diamond	Exterior	Sencote	20° Plastic Strip	2.3M	HJ25ADBS*
2 1/2" x .131"	Diamond	Galv	Sencote	20° Plastic Strip	2.5M	KD25AABS
3" x .131"	Diamond	Hot Dip	Sencote	20° Plastic Strip	2.5M	KD27ASBS
3 1/4" x .131"	Diamond	Hot Dip	Sencote	20° Plastic Strip	2.5M	KD28ASBS
3 1/2" x .131"	Diamond	Hot Dip	Sencote	20° Plastic Strip	2.5M	KD29ASBS
3 1/4" x .131"	Diamond	Stainless 304	Sencote	20° Plastic Strip	1M	KD28AGBS

\*Roof tile nails, drive with FramePro® 725XP or SN952XP

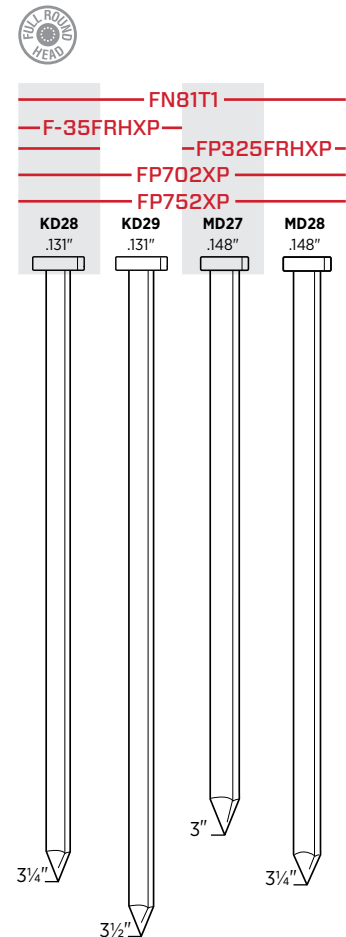
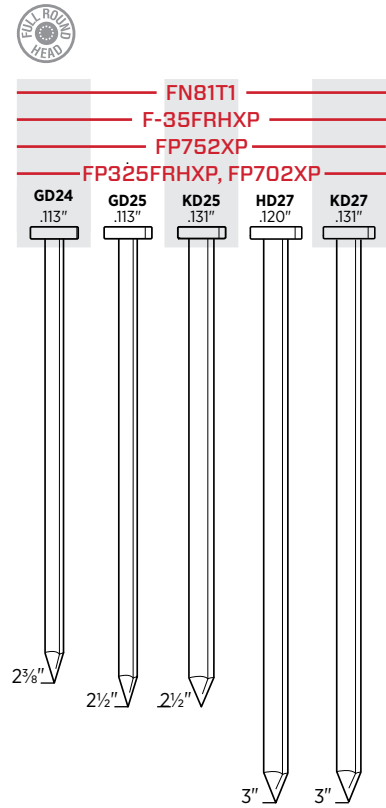

# FRAMING, SHEATHING & SUBFLOOR FASTENERS

## 20° Ring Shank Plastic Collated Nails

Framing, sheathing, subfloor, decks, trusses and pallets

Length	Point	Finish	Coating	Collation	Box Count	Item Code
2" x .113"	Diamond	Bright	Sencote	20° Plastic Strip	5M	GL21APBSN
2 3/8" x .113"	Diamond	Bright	Sencote	20° Plastic Strip	5M	GL24APBSN
2" x .113"	Diamond	Hot Dip	Sencote	20° Plastic Strip	2.5M	GL21ASBS
2 3/8" x .113"	Diamond	Galv	Sencote	20° Plastic Strip	5M	GL24AABSN
2 3/8" x .113"	Diamond	Hot Dip	Sencote	20° Plastic Strip	2.5M	GL24ASBS
3" x .120"	Diamond	Hot Dip	Sencote	20° Plastic Strip	2.5M	HL27ASBS
2 3/8" x .113"	Diamond	Stainless 304	Sencote	20° Plastic Strip	1M	GL24AGBS
3" x .120"	Diamond	Stainless 304	Sencote	20° Plastic Strip	1M	HL27AGBS

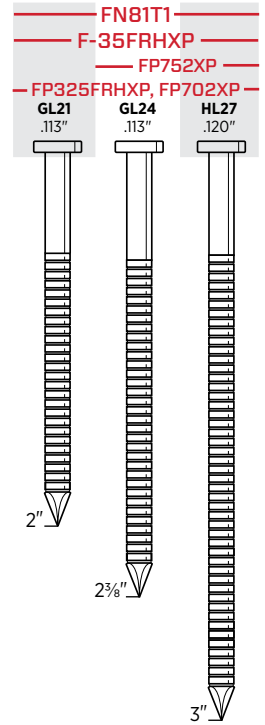

## 15° Ring Shank Subflooring Nails

Superior fastening in subfloor applications

Length	Point	Finish	Coating	Collation	Box Count	Item Code
2" x .099"	Diamond	Bright Basic	Sencote	15° Flat Wire Welded Coil	6.6M	BT21APBF
2 3/8" x .113"	Diamond	Bright Basic	Sencote	15° Flat Wire Welded Coil	4M	GT24APBF
2 1/2" x .131"	Diamond	Bright Basic	Sencote	15° Flat Wire Welded Coil	4M	KT25APBF

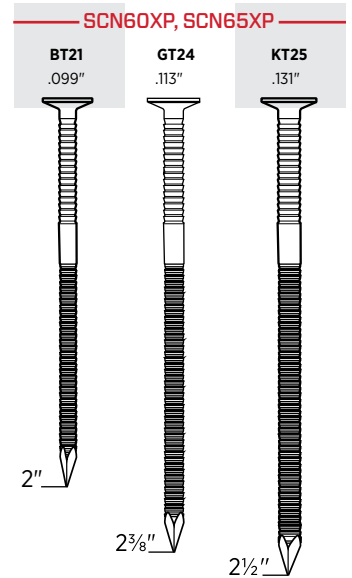

## Subfloor and Sheathing Coil Nails

- Superior fastening in floor applications
- Tested and proven to reduce squeaky subfloors, uneven surfaces, and raised nail heads
- Unique double rings shank design reduces the potential of nails backing out, one of the most common flooring problems

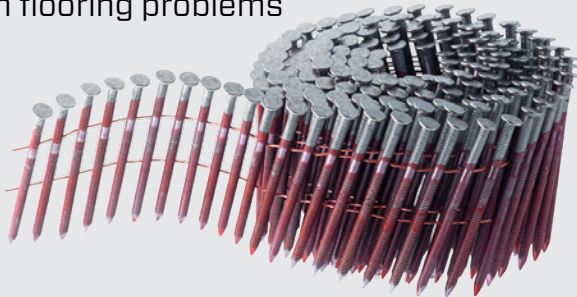

# FRAMING, SHEATHING & SUBFLOOR FASTENERS

## 15° Smooth Shank Coil Nails

Framing, sheathing, pallets, subfloor, decks and trusses						
Length	Point	Finish	Coating	Collation	Box Count	Item Code
2" x .113"	Diamond	Bright	Sencote	15° Flat Wire Welded Coil	6M	GD21APBF
2½" x .113"	Diamond	Bright	Sencote	15° Flat Wire Welded Coil	6M	GD25APBF
2½" x .131"	Diamond	Bright	Sencote	15° Flat Wire Welded Coil	3.6M	KD25APBF
3" x .120"	Diamond	Bright	Sencote	15° Flat Wire Welded Coil	4M	HD27APBF
3" x .131"	Diamond	Bright	Sencote	15° Flat Wire Welded Coil	3.6M	KD27APBF
3¼" x .131"	Diamond	Bright	Sencote	15° Flat Wire Welded Coil	3.6M	KD28APBF
3½" x .131"	Diamond	Bright	Sencote	15° Flat Wire Welded Coil	3.6M	KD29APBF
5" x .148"	Diamond	Bright	Sencote	15° Flat Wire Welded Coil	1.8M	MD34APBF
2" x .113"	Diamond	Galv	Sencote	15° Flat Wire Welded Coil	6M	GD21AABF
2½" x .113"	Diamond	Galv	Sencote	15° Flat Wire Welded Coil	6M	GD25AABF
3" x .131"	Diamond	Hot Dip	Sencote	15° Flat Wire Welded Coil	2.4M	KD27ASBF
3¼" x .131"	Diamond	Hot Dip	Sencote	15° Flat Wire Welded Coil	2.4M	KD28ASBF

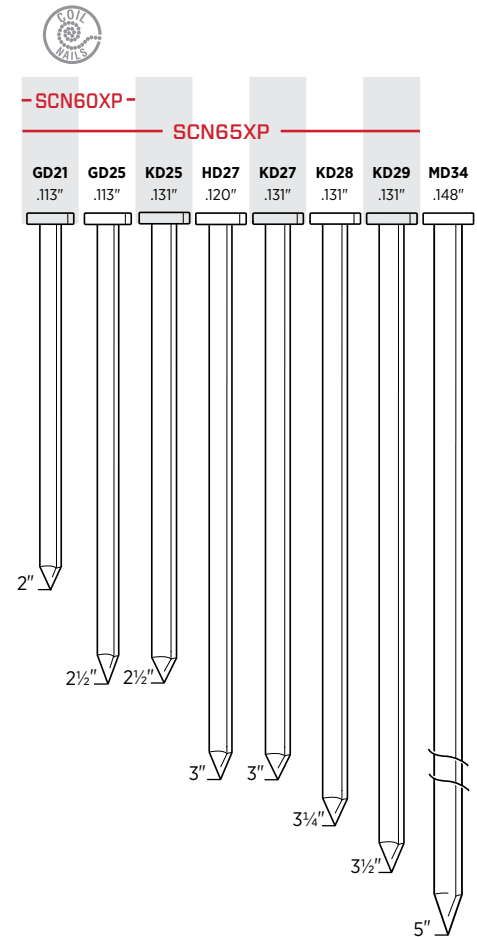

## 15° Ring Shank Coil Nails

Framing, sheathing, pallets, subfloor, decks and trusses						
Length	Point	Finish	Coating	Collation	Box Count	Item Code
2" x .099"	Diamond	Bright	Sencote	15° Flat Wire Welded Coil	6.6M	BL21APBF
2" x .099"	Diamond	Bright	Sencote	15° Flat Wire Welded Coil	6.6M	BT21APBF
2" x .113"	Diamond	Bright	Sencote	15° Flat Wire Welded Coil	6M	GL21APBF
2¾" x .113"	Diamond	Bright	Sencote	15° Flat Wire Welded Coil	6M	GL24APBF
2¼" x .099"	Diamond	Galv	Sencote	15° Flat Wire Welded Coil	6.6M	BE23AABF
2¾" x .113"	Diamond	Hot Dip	Sencote	15° Flat Wire Welded Coil	2.7M	GL24ASBF
3" x .120"	Diamond	Hot Dip	Sencote	15° Flat Wire Welded Coil	2.4M	HL27ASBF
2¾" x .113"	Diamond	Stainless 304	Sencote	15° Flat Wire Welded Coil	2.7M	GL24AGBF

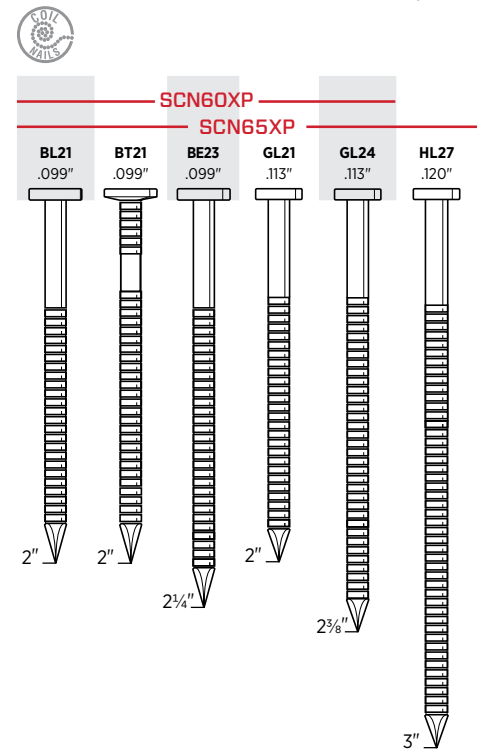



# FRAMING, SHEATHING & SUBFLOOR FASTENERS

## 15° Screw Shank Coil Nails

Framing, sheathing, pallets, subfloor, decks and trusses						
Length	Point	Finish	Coating	Collation	Box Count	Item Code
2" x .099"	Blunt Dia.	Bright	Sencote	15° Flat Wire Welded Coil	9M	BK21BPBFN
2¼" x .099"	Blunt Dia.	Bright	Sencote	15° Flat Wire Welded Coil	9M	BK23BPBFN
2½" x .099"	Blunt Dia.	Bright	Sencote	15° Flat Wire Welded Coil	6M	BK25BPBFN
3" x .120"	Diamond	Bright	Sencote	15° Flat Wire Welded Coil	4M	HK27APBFN

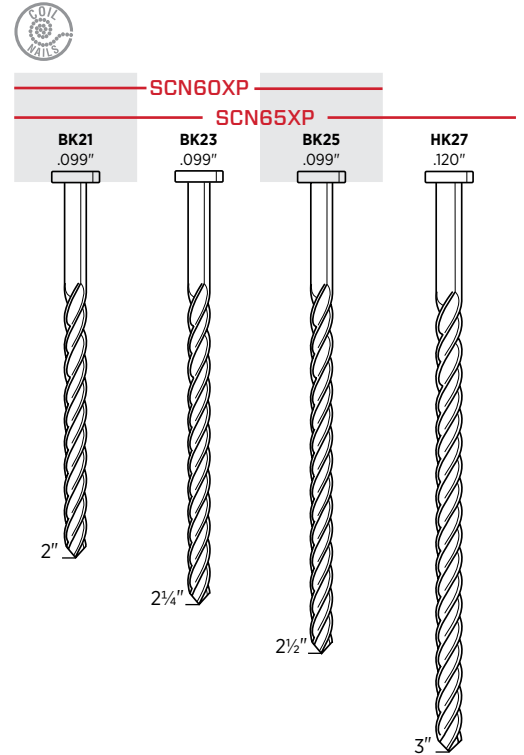

## 15° Smooth Shank Stiff-Stock Coil Nails

For fastening wood to masonry						
Length	Point	Finish	Coating	Collation	Box Count	Item Code
1½" x .099"	Diamond	Bright	Sencote	15° Flat Wire Welded Coil	3M	M003011

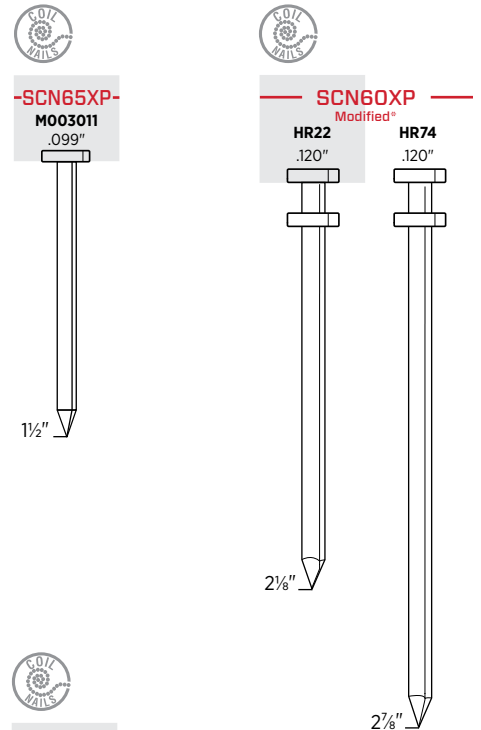

## 15° Duplex Smooth Shank Coil Nails\*

Framing, trusses, crating and concrete forms						
Length	Point	Finish	Coating	Collation	Box Count	Item Code
2½" x .120"	Diamond	Bright	Plain	15° Flat Wire Welded Coil	5.4M	HR22APAF
2¾" x .120"	Diamond	Bright	Plain	15° Flat Wire Welded Coil	3.6M	HR74APAF

\*Requires a special-order modified SCN60XP tool (order XA1739)

## 15° Drywall Ring Shank Bugle Head Coil Nails

For fastening drywall to wood						
Length	Point	Finish	Coating	Collation	Box Count	Item Code
1½" x .099"	Diamond	Galv	Plain	15° Conical Wire Welded Coil	6.4M	BG17AAAQ
1¾" x .099"	Diamond	Galv	Plain	15° Conical Wire Welded Coil	6.4M	BG18AAAQ

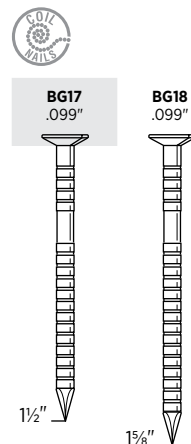

# FRAMING, SHEATHING & SUBFLOOR FASTENERS

## 0° Collated Concrete and Steel Pins

For fastening drywall track, wood furring, hat channels, metal washers or ceiling grid to concrete, concrete block and steel

Length	Point	Finish	Coating	Collation	Box Count	Item Code
1/2" x .109"/.118"	Pinched	Zinc Plated	Plain	Straight Plastic Collated Strip	1M	W3050YXS
3/4" x .109"	Pinched	Zinc Plated	Plain	Straight Plastic Collated Strip	1M	W3075YXC
1" x .109"	Pinched	Zinc Plated	Plain	Straight Plastic Collated Strip	1M	W3100YXC
1 1/4" x .109"	Pinched	Zinc Plated	Plain	Straight Plastic Collated Strip	1M	W3125YXC
1 1/2" x .109"	Pinched	Zinc Plated	Plain	Straight Plastic Collated Strip	1M	W3150YXC

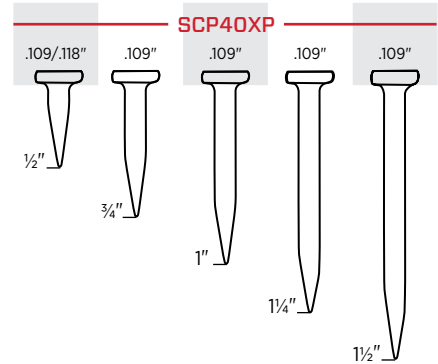

## 34° Hardened Metal Connector Nails

Joist hangers, foundation anchors, seismic and hurricane straps and ties

Length	Point	Finish	Coating	Collation	Box Count	Item Code
1 1/2" x .148"	Diamond	Bright	Plain	34° Paper Tape Strip	3M	MD17AQBD
2 1/2" x .148"	Diamond	Bright	Plain	34° Paper Tape Strip	2.5M	MD25AQBDN
2 1/2" x .162"	Diamond	Bright	Plain	34° Paper Tape Strip	2M	ND25AQBDN
1 1/2" x .148"	Diamond	Hot Dip	Plain	34° Paper Tape Strip	3M	MD17AJBDN
2 1/2" x .148"	Diamond	Hot Dip	Plain	34° Paper Tape Strip	2.5M	MD25AJBDN
2 1/2" x .162"	Diamond	Hot Dip	Plain	34° Paper Tape Strip	2M	ND25AJBDN

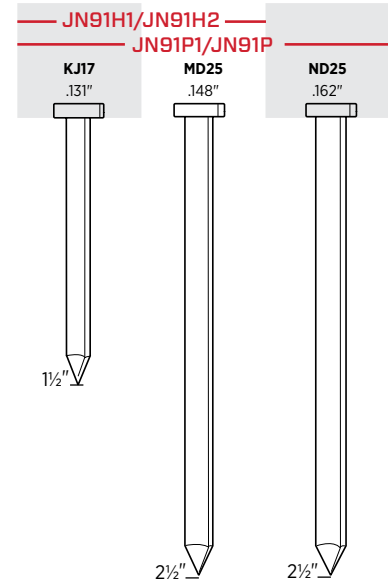

## 34° Heat Treated Metal Connector Nails

Joist hangers, foundation anchors, seismic and hurricane straps and ties

Length	Point	Finish	Coating	Collation	Box Count	Item Code
1 1/2" x .131"	Diamond	Bright	Plain	34° Paper Tape Strip	2M	KJ17AHBD
2 1/2" x .148"	Diamond	Bright	Plain	34° Paper Tape Strip	1.5M	MD25AHBD
1 1/2" x .131"	Diamond	Hot Dip	Plain	34° Paper Tape Strip	2M	KJ17AEBD

## 34° Non-Heat Treated Metal Connector Nails

Standard tensile, non-hardened nails for use in joist hangers, foundation anchors, seismic and hurricane straps and ties

Length	Point	Finish	Coating	Collation	Box Count	Item Code
1 1/2" x .131"	Diamond	Bright	Plain	34° Paper Tape Strip	2M	M002261
1 1/2" x .148"	Diamond	Bright	Plain	34° Paper Tape Strip	2M	M002263
2 1/2" x .148"	Diamond	Bright	Plain	34° Paper Tape Strip	1.5M	M002265
1 1/2" x .131"	Diamond	Hot Dip	Plain	34° Paper Tape Strip	2M	M002262
1 1/2" x .148"	Diamond	Hot Dip	Plain	34° Paper Tape Strip	2M	M002264
2 1/2" x .148"	Diamond	Hot Dip	Plain	34° Paper Tape Strip	1.5M	M002266

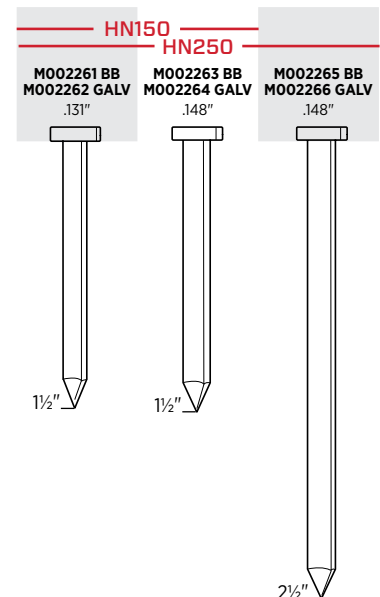

# FRAMING, SHEATHING & SUBFLOOR FASTENERS

16<sup>GA</sup>

## 1" Crown Heavy Wire Staples

Sheathing, house wrap, composite roofing, roofing felt, corrugated containers, foam insulation board, furniture/cabinet frames and butt joints

Length	Point	Finish	Coating	Collation	Box Count	Item Code
3/8"	Chisel	Galv	Plain	Glued	10M	P06BAA*
1/2"	Chisel	Galv	Sencote	Taped	10M	P08BABT*
5/8"	Chisel	Galv	Sencote	Taped	10M	P10BAB*
5/8"	Divergent	Galv	Sencote	Glued	10M	P10FAB*
5/8"	Chisel	Galv	Coated	Glued	10M	P10BPE*
3/4"	Chisel	Galv	Sencote	Taped	10M	P11BAB
3/4"	Chisel	Galv	Coated	Glued	10M	P11BPE
7/8"	Chisel	Galv	Sencote	Taped	10M	P12BAB
1"	Chisel	Galv	Sencote	Taped	10M	P13BAB
1"	Chisel	Galv	Sencote	Glued	10M	P13BPE
1 1/4"	Chisel	Galv	Sencote	Taped	10M	P15BAB
1 1/4"	Chisel	Galv	Coated	Glued	10M	P15BPE
1 1/2"	Chisel	Galv	Sencote	Taped	10M	P17BAB
1 3/4"	Chisel	Galv	Sencote	Taped	5M	P19BAB
2"	Chisel	Galv	Sencote	Taped	5M	P21BAB
1"	Outside Chisel	Stainless 304	Sencote	Taped	5M	P13BGBN

\*Use kit #YK0883 with PS15XP for 3/8"-5/8" staples

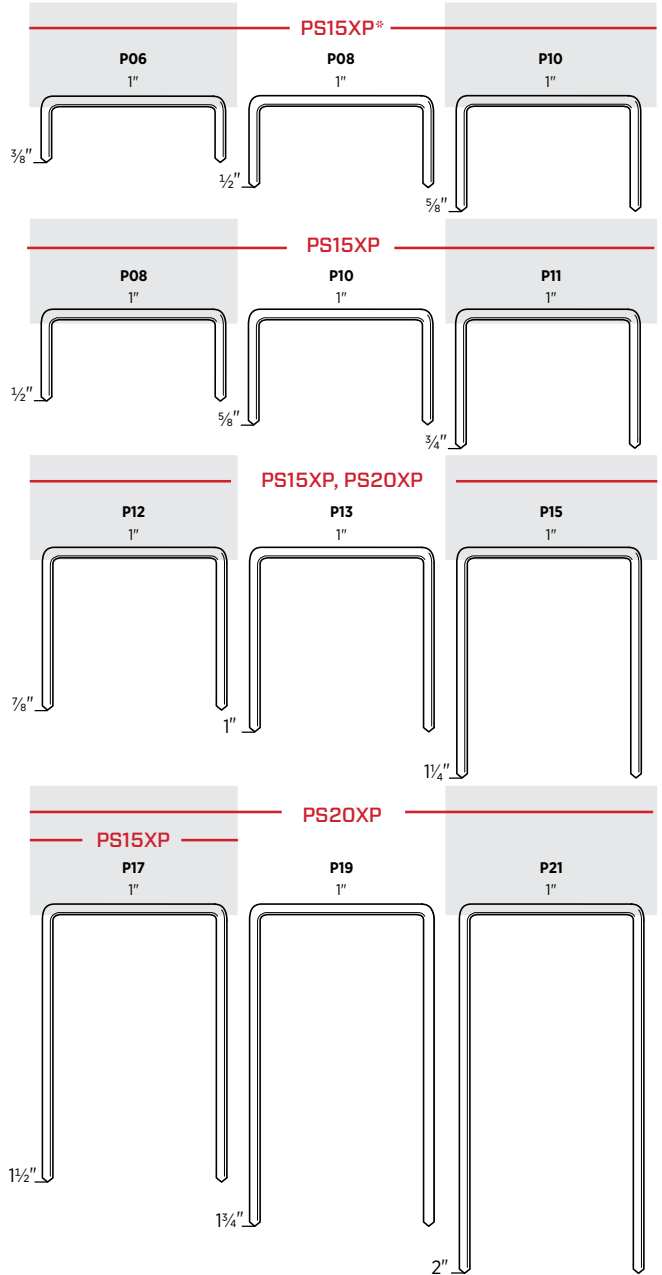

17<sup>GA</sup>

## 7/16" Crown Heavy Wire Staples\*

Sheathing, subfloor, furniture frames and crates

Length	Point	Finish	Coating	Collation	Box Count	Item Code
1 1/4"	Chisel	Bright	Sencote	Glued	21.12M	O15BRBBN
1 3/8"	Chisel	Bright	Sencote	Glued	17.6M	O16BRBBN
1 1/2"	Chisel	Bright	Sencote	Glued	17.6M	O17BRBBN
1 5/8"	Chisel	Bright	Sencote	Glued	17.6M	O18BRBBN
1 3/4"	Chisel	Bright	Sencote	Glued	14.08M	O19BRBBN

\*Compatible with NS20XP, NS20BXP, SNS200XP, SNS200XP-BST, SNS41 staplers manufactured after 09/2010. SNS44XP and SNS45XP staplers manufactured after 05/2010. For older tools, order upgrade kits SNS41-YK0794, SNS44-YK0793, SNS45-FA0186.

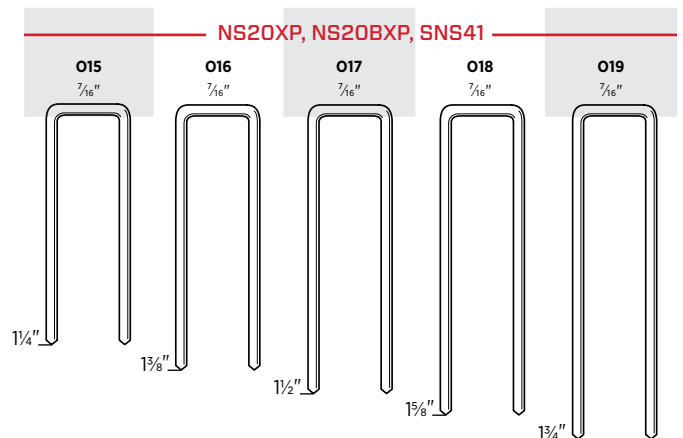

# FRAMING, SHEATHING & SUBFLOOR FASTENERS

16<sup>GA</sup>

## 1/16" Crown Heavy Wire Staples

Sheathing, soffits, underlayment, lattice, cabinets, casebacks and drawers

Length	Point	Finish	Coating	Collation	Box Count	Item Code
3/4"	Chisel	Bright	Sencote	Glued	5M	N11BRB
1"	Chisel	Bright	Sencote	Glued	5M	N13BRB
1 1/8"	Chisel	Bright	Sencote	Taped	10M	N14BRB
1 1/4"	Chisel	Bright	Sencote	Taped	10M	N15BRB
1 3/8"	Chisel	Bright	Sencote	Taped	10M	N16BRB
1 1/2"	Chisel	Bright	Sencote	Taped	10M	N17BRB
1 5/8"	Chisel	Bright	Sencote	Taped	10M	N18BRB
1 3/4"	Chisel	Bright	Sencote	Taped	10M	N19BRB
2"	Chisel	Bright	Sencote	Taped	10M	N21BRB
1/2"	Chisel	Galv	Sencote	Glued	5M	N08BABN
1/2"	Chisel	Galv*	Sencote	Glued	5M	N08BBBN
1/2"	Diverg	Galv*	Sencote	Glued	5M	N08FBB
5/8"	Chisel	Galv*	Sencote	Glued	5M	N10BAB
3/4"	Chisel	Galv	Sencote	Glued	5M	N11BAB
3/4"	Diverg	Galv*	Sencote	Glued	5M	N11FBB
7/8"	Chisel	Galv	Sencote	Glued	5M	N12BABN
7/8"	Diverg	Galv	Sencote	Glued	5M	N12FABN
1"	Chisel	Galv	Sencote	Glued	5M	N13BAB
1"	Diverg	Galv	Sencote	Glued	5M	N13FAB
1 1/8"	Chisel	Galv	Sencote	Taped	10M	N14BAB
1 1/4"	Chisel	Galv	Sencote	Taped	10M	N15BAB
1 1/4"	Diverg	Galv	Sencote	Glued	10M	N15FAB
1 3/8"	Chisel	Galv	Sencote	Taped	10M	N16BAB
1 1/2"	Chisel	Galv	Sencote	Taped	10M	N17BAB
1 5/8"	Chisel	Galv	Sencote	Taped	10M	N18BAB
1 3/4"	Chisel	Galv	Sencote	Taped	10M	N19BAB
2"	Chisel	Galv	Sencote	Taped	10M	N21BAB
1 1/4"	Chisel	Stainless 304	Sencote	Glued	3M	N15BGB
1 1/2"	Chisel	Stainless 304	Sencote	Glued	3M	N17BGB
1 3/4"	Chisel	Stainless 304	Sencote	Glued	3M	N19BGBN
2"	Chisel	Stainless 304	Sencote	Glued	3M	N21BGBN

\*Galvanized High-Tensile Steel

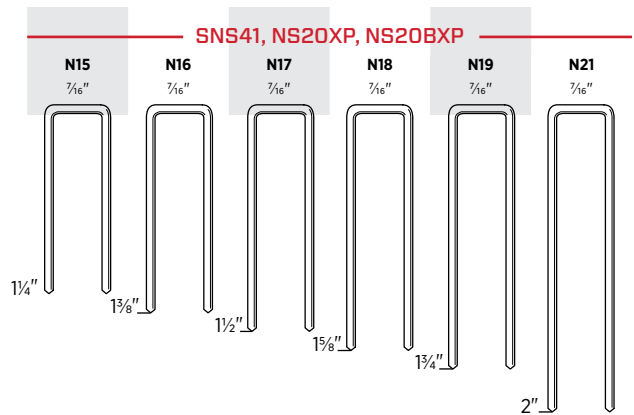
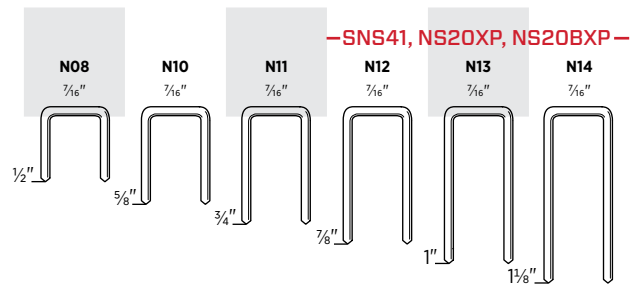

15<sup>GA</sup>

## 1/16" Crown Heavy Wire Staples

Framing, sheathing, subflooring, decking, lathing, door and window units, fencing, pallets, crate and box assembly, furring and furniture framing

Length	Point	Finish	Coating	Collation	Box Count	Item Code
1 1/2"	Chisel	Bright	Sencote	Taped	5M	Q17BRB
1 3/4"	Chisel	Bright	Sencote	Taped	5M	Q19BRB
2"	Chisel	Bright	Sencote	Taped	5M	Q21BRB
2 1/4"	Chisel	Bright	Sencote	Taped	5M	Q23BRB
2 1/2"	Chisel	Bright	Sencote	Taped	5M	Q25BRB
1 1/4"	Chisel	Galv	Sencote	Taped	5M	Q15BAB
1 1/2"	Chisel	Galv	Sencote	Taped	5M	Q17BAB
1 3/4"	Chisel	Galv	Sencote	Taped	5M	Q19BAB
2"	Chisel	Galv	Sencote	Taped	5M	Q21BAB
2 1/2"	Chisel	Galv	Sencote	Taped	5M	Q25BAB
1 3/4"	Chisel	Stainless 304	Sencote	Taped	2.2M	Q19BGBN
2 1/2"	Chisel	Stainless 304	Sencote	Taped	1M	Q25BGBN

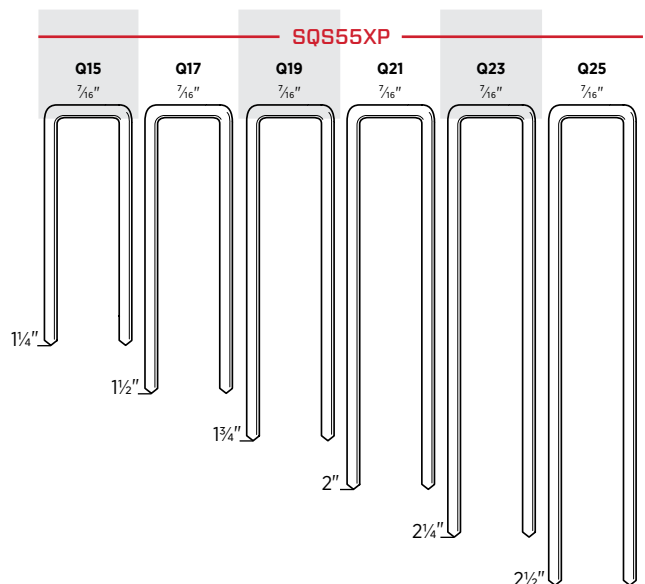



# ROOFING, SIDING & FENCING

## WE COVER IT ALL

When it comes to roofing applications or installing siding, uptime is everything. SENCO has designed a full line of tools and fasteners to maximize your productivity.

Our RoofPro™445XP with its innovative firing valve uses 5% less air. A bi-metal driver blade increases durability. And our power in, power out feed system is air driven for stability and speed.

### APPLICATIONS

SENCO offers a variety of coil nailers and crown staplers with fasteners optimized for different types of shingles, siding, sheathing, and felt underlayment.

### KEY FEATURES

- High-strength housings
- Long-lasting wear plates
- Easy, one-handed operation
- Adjustable depth-of-drive



## RoofPro™445XP

1¾" COIL NAILER

ITEM #8V0001N

15°



### Features

- Innovative firing valve reduces air consumption without compromising power or speed
- Bi-metal driver blade reduces wear and improves durability
- Power in, power out feed system improves speed and delivers consistent drives
- Metal wear plate in nail canister reduces wear and helps improve nail feed
- Adjustable and removable shingle guide

## SN71P1

2½" COIL NAILER

15°



### Features

- Dual collation – allows the choice between wire or plastic collation
- Tool-free depth of drive
- High load capacity (up to 375 nails)
- Overmold grip
- Rotatable rafter hook
- EZ-Load design



**RoofPro™445XP**  
Blows the Roof off the Competition

It doesn't cost a bundle to drive the very best.



— Building Code Approved  
— Professional Performance

## Product Reference Chart

TOOL SPECS	RoofPro™445XP	SN71P1
<b>Trigger</b>	Contact	Selectable
<b>Operating Pressure</b>	70-120 psi (4.8-8.3 bar)	70-120 psi (4.8-8.3 bar)
<b>Air Consumption</b> (60 CPM)	3.86 scfm	4.6 scfm
<b>Air Inlet</b>	¼" NPT	⅜" NPT
<b>Weight</b>	5.2 lbs (2.35 kg)	5.58 lbs (2.53 kg)
<b>Height</b>	10.9" (276 mm)	12.75" (324 mm)
<b>Length</b>	10.6" (269 mm)	11.63" (295 mm)
<b>Width</b>	4.5" (114 mm)	5.06" (129 mm)
<b>Main Body Material</b>	Aluminum	Magnesium
<b>Warranty</b>	5 yrs	5 yrs
<b>FASTENER SPECS</b>	Fasteners are located on pages 51-52	
<b>Range</b>	¾"-1¼"	1¼"-2½"
<b>Shank</b>	.120"	.082"-.092"
<b>Capacity</b>	120	250-375
<b>Angle/Collation</b>	15° Flat Wire Welded Coil	15° Flat Wire Welded or Plastic Carrier Coil
<b>Series</b>	HJ, M00	ED, EJ, EL, SE
<b>TOOL FEATURES</b>		
<b>Depth-of-Drive</b>	Yes, Tool-Free	Yes, Tool-Free
<b>Tool-Free Jam Clearing</b>	Yes	Yes
<b>Adjustable Exhaust</b>	No	Yes

## PS15RXP

1" CROWN 1½" ROOFING STAPLER

ITEM #9U0001N

16<sub>GA</sub>



### Features

- Enhanced EZ-Clear™ latch allows for quick access to clear fasteners
- New aggressive locking feature offers pinpoint accuracy and unrivaled driveability
- Updated drive track eliminates staple movement, virtually eliminating jams
- Positive-locking adjustable depth-of-drive ensures consistently flush drives
- Hardened wear plates and safety protect tool from shingle damage

## BC58

½" CROWN ⅝" STAPLE + 1" CAP

ITEM #4A0001N

21<sub>GA</sub>



### Features

- EZ-Load system for staples and caps
- Ultra-lightweight for ease of use and maneuverability
- Balanced and fast for greater productivity
- Side-mounted cap collator holds caps regardless of tool position

## A11

⅞" CROWN ⅜" HAMMER STAPLER

ITEM #PC0700

20<sub>GA</sub>



### Features

- Rugged all-steel construction
- Easy to service and maintain
- Comfortable fluted handle with grip

## Product Reference Chart

TOOL SPECS	PS15RXP	BC58	A11
<b>Trigger</b>	Contact	Contact	—
<b>Operating Pressure</b>	70–120 psi (4.8–8.3 bar)	60–95 psi (4.1–6.5 bar)	—
<b>Air Consumption (60 CPM)</b>	3.18 scfm	.77 scfm	—
<b>Air Inlet</b>	⅜" NPT	¼" NPT	—
<b>Weight</b>	5.5 lbs (2.5 kg)	4.1 lbs (2 kg)	2 lbs (.9 kg)
<b>Height</b>	9" (229 mm)	8.5" (216 mm)	1.75" (44.4 mm)
<b>Length</b>	15.25" (387 mm)	12.5" (317 mm)	12.3" (312.4 mm)
<b>Width</b>	4" (105 mm)	3.5" (89 mm)	—
<b>Main Body Material</b>	Aluminum	Aluminum	Steel
<b>Warranty</b>	5 yrs	5 yrs	1 yr
<b>FASTENER SPECS</b>	Fasteners are located on page 53		
<b>Gauge</b>	16	21	20
<b>Crown</b>	1"	½"	⅞"
<b>Range</b>	⅝"–1½"	⅝" Galv.	⅜"
<b>Capacity</b>	160	110	168
<b>Angle/Collation</b>	Taped and taped glued	Glued Staple, Laser Welded Cap	Straight Glued Strip
<b>Series</b>	P	M004092, Cap	H
<b>TOOL FEATURES</b>			
<b>Depth-of-Drive</b>	Yes, Tool-Free	No	—
<b>Tool-Free Jam Clearing</b>	Yes	No	Yes
<b>Adjustable Exhaust</b>	No	Yes	—

# ROOFING, SIDING & FENCING FASTENERS

## 15° Smooth Shank Coil Nails

Siding, asphalt and fiberglass shingles and vapor barriers

Length	Point	Finish	Coating	Collation	Box Count	Item Code
¾" x .120"	Diamond	Galv	Plain	15° Flat Wire Welded Coil	7.2M	M003101
1" x .120"	Diamond	Galv	Plain	15° Flat Wire Welded Coil	7.2M	M003103
1¼" x .120"	Diamond	Galv	Plain	15° Flat Wire Welded Coil	7.2M	M003104
1½" x .120"	Diamond	Galv	Plain	15° Flat Wire Welded Coil	7.2M	M003105
1¾" x .120"	Diamond	Galv	Plain	15° Flat Wire Welded Coil	7.2M	M003106

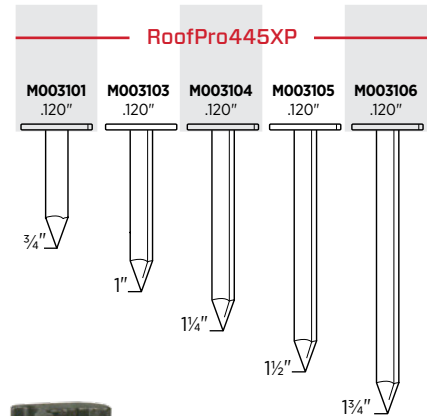

## Vinyl Siding Attachment (Sold Separately)

Convert RoofPro™445XP and RoofPro™455XP into vinyl siding nailer

Fits Tool	Item Code
RoofPro™445XP	HA0308
RoofPro™455XP	MA0013



## 15° Smooth Shank Coil Nails

Siding, packaging, fencing, pallets and underlayment

Length	Point	Finish	Coating	Collation	Box Count	Item Code
1½" x .099"	Diamond	Bright	Sencote	15° Plastic Carrier Coil	6M	BD17APBC
2" x .092"	Diamond	Exterior	Sencote	15° Flat Wire Welded Coil	7.2M	EJ21ADBH
2¼" x .092"	Diamond	Galv	Sencote	15° Flat Wire Welded Coil	3.6M	ED23AABH
2¼" x .092"	Diamond	Exterior	Sencote	15° Conical Wire Welded Coil	7.2M	EJ23ADBH
2¼" x .092"	Diamond	Hot Dip	Sencote	15° Plastic Carrier Coil	3.6M	EJ23ASBC

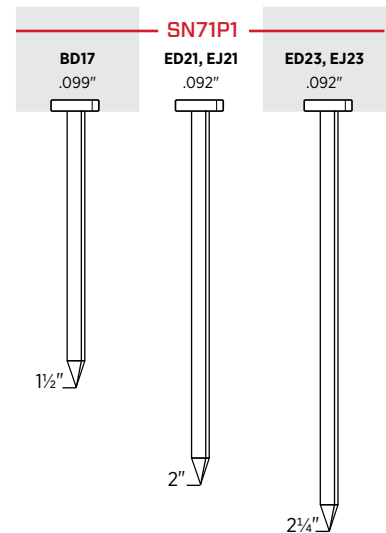



**15°** Ring Shank Coil Nails

Siding, packaging, fencing, wood shingles, crating and pallets						
Length	Point	Finish	Coating	Collation	Box Count	Item Code
1/4" x .082"	Diamond	Bright	Sencote	15° Conical Wire Welded Coil	15M	SE15APB
1/4" x .082"	Diamond	Bright	Sencote	15° Flat Wire Welded Coil	14M	SE15APBH
1/2" x .082"	Diamond	Bright	Sencote	15° Flat Wire Welded Coil	11.2M	SE17APBH
3/4" x .082"	Diamond	Bright	Sencote	15° Conical Wire Welded Coil	12M	SE19APB
1 3/4" x .092"	Diamond	Hot Dip	Sencote	15° Flat Wire Welded Coil	3.6M	EL19ASBH
1 7/8" x .092"	Diamond	Galv	Sencote	15° Flat Wire Welded Coil	3.6M	EL20AABH
1 7/8" x .092"	Diamond	Hot Dip	Sencote	15° Flat Wire Welded Coil	3.6M	EL20ASBH
2" x .092"	Diamond	Hot Dip	Sencote	15° Flat Wire Welded Coil	3.6M	EL21ASBH
2 1/4" x .092"	Diamond	Galv	Sencote	15° Flat Wire Welded Coil	3.6M	EL23AABH
2 1/4" x .092"	Diamond	Hot Dip	Sencote	15° Plastic Carrier Coil	3.6M	EL23ASBC
2 1/4" x .092"	Diamond	Hot Dip	Sencote	15° Flat Wire Welded Coil	3.6M	EL23ASBH
1 3/4" x .092"	Diamond	Stainless 304	Sencote	15° Flat Wire Welded Coil	3.6M	EL19AGBH
2" x .092"	Diamond	Stainless 304	Sencote	15° Flat Wire Welded Coil	3.6M	EL21AGBH
2 1/4" x .092"	Diamond	Stainless 304	Sencote	15° Flat Wire Welded Coil	3.6M	EL23AGBH

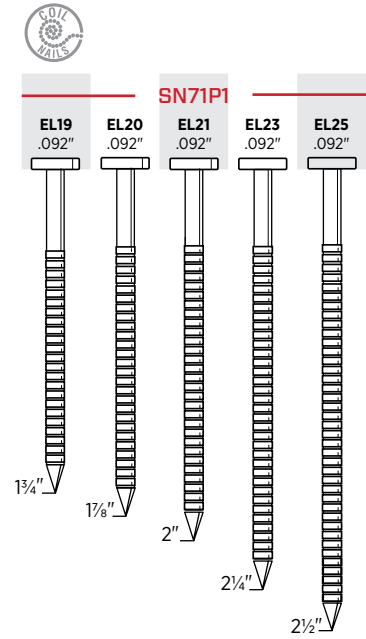
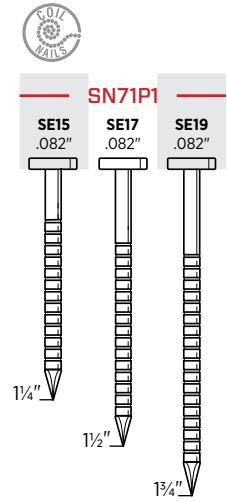

# ROOFING, SIDING & FENCING FASTENERS

16<sup>GA</sup>

## 1" Crown Heavy Wire Staples

Composite roofing, roofing felt, foam insulation board, house wrap, sheathing, corrugated containers, furniture/cabinets and butt joints

Length	Point	Finish	Coating	Collation	Box Count	Item Code
3/8"	Chisel	Galv	Plain	Glued	10M	P06BAA*
1/2"	Chisel	Galv	Sencote	Taped	10M	P08BAPT*
5/8"	Chisel	Galv	Sencote	Taped	10M	P10BAB*
5/8"	Divergent	Galv	Sencote	Glued	10M	P10FAB*
5/8"	Chisel	Galv	Coated	Glued	10M	P10BPE*
3/4"	Chisel	Galv	Sencote	Taped	10M	P11BAB
3/4"	Chisel	Galv	Coated	Glued	10M	P11BPE
7/8"	Chisel	Galv	Sencote	Taped	10M	P12BAB
1"	Chisel	Galv	Sencote	Taped	10M	P13BAB
1"	Chisel	Galv	Sencote	Glued	10M	P13BPE
1 1/4"	Chisel	Galv	Sencote	Taped	10M	P15BAB
1 1/4"	Chisel	Galv	Coated	Glued	10M	P15BPE
1 1/2"	Chisel	Galv	Sencote	Taped	10M	P17BAB
1"	Outside Chisel	Stainless 304	Sencote	Taped	5M	P13BGBN

\*Use kit #YK0883 with PS15RXP for 3/8"-5/8" staples

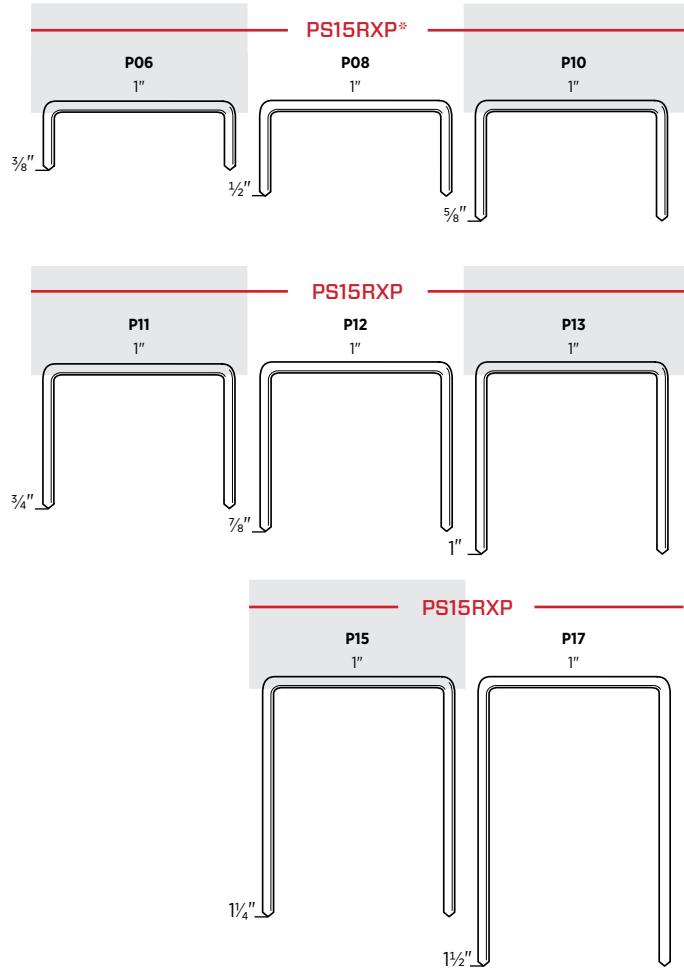

20<sup>GA</sup>

## 7/16" Crown Fine Wire Staples

Roofing, insulation and vapor barriers

Length	Point	Finish	Coating	Collation	Box Count	Item Code
3/8"	Chisel	Galv	Plain	Glued	5M	H06BAA

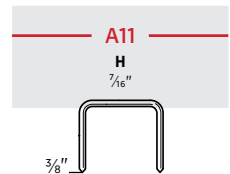

21<sup>GA</sup>

## 1" Cap & 1/2" Crown Staples

Roof felt installation and house wrap

Length	Point	Finish	Coating	Collation	Box Count	Item Code
3/8"	Chisel	Galv	Plain	Glued	2.2M	M004092
1"	—	Plastic	—	Laser Weld	2.2M	—

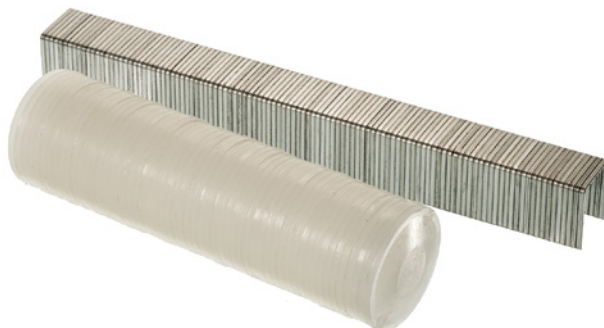
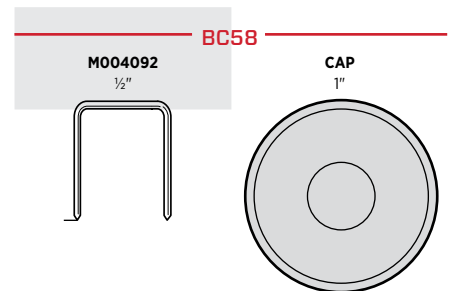

# PALLETS & CRATING

## THE DURABILITY TO DRIVE ALL DAY

SENCO's PalletPro™ heavy-duty coil nailers are built specifically for the challenges of pallets and crating. The PalletPro130 can drive fasteners as long as 5½" and hold up to 225 nails.

### APPLICATIONS

Pallets, crates, heavy-duty framing and truss attachment

### KEY FEATURES

- Durable drivers and bumpers
- Flexible collation deflectors
- Dust guards for safe operation and extended use

Clinch and sisal anvil staple tools come in 18 and 20 gauge ½" and 7/16" crowns. Great for hand-held or mounted applications.

### APPLICATIONS

Packaging, corrugated box fabrication, shoe making and bedding: basically any time two materials must be stapled and clinched together

### FEATURES

- High-capacity magazines
- Extended reach capability
- Tool-free adjustable anvil opening
- Bottom-load magazines



## PalletPro™57FXP

2¼" COIL NAILER

ITEM #4L0001N

15°



### Features

- High load capacity
- Ultra-durability driver and piston bumper for long life
- Adjustable nail canister accommodates wide range of nails
- Body protection — side steel wear plates reduce abrasion of tool

## PalletPro™100XP

4" COIL NAILER (SPECIAL ORDER TOOL)

ITEM #5L0001N

15°



### Features

- High load capacity
- Includes optional heavy-duty threaded T-handle
- Flexible collation deflector and dust guard for improved safety in commercial environments
- Strengthened driver and bumper for extended use and reliable service

## PalletPro™130XP

5⅞" COIL NAILER (SPECIAL ORDER TOOL)

ITEM #5M0001N

15°



### Features

- High load capacity
- Includes optional heavy-duty threaded T-handle
- Flexible collation deflector and dust guard for improved safety in commercial environments
- Strengthened driver and bumper for extended use and reliable service

## Product Reference Chart

TOOL SPECS	PalletPro™57FXP	PalletPro™100XP	PalletPro™130XP
<b>Trigger</b>	Contact	Contact	Sequential
<b>Operating Pressure</b>	70–120 psi (4.9–8.4 bar)	70–120 psi (4.9–8.4 bar)	70–120 psi (4.9–8.4 bar)
<b>Air Consumption (60 CPM)</b>	3.07 scfm	11.4 scfm	11.4 scfm
<b>Air Inlet</b>	¾" NPT	¾" NPT	¾" NPT
<b>Weight</b>	5.9 lbs (2.67 kg)	11.5 lbs (5.24 kg)	13 lbs (5.9 kg)
<b>Height</b>	11.25" (286 mm)	16.5" (418 mm)	18" (457 mm)
<b>Length</b>	11.88" (302 mm)	13.25" (338 mm)	13" (330 mm)
<b>Width</b>	5.25" (123 mm)	6" (153 mm)	6.6" (168 mm)
<b>Main Body Material</b>	Aluminum	Aluminum	Aluminum
<b>Warranty</b>	5 yrs	5 yrs	5 yrs
<b>FASTENER SPECS</b>	Fasteners are located on pages 58–59		
<b>Range</b>	1"–2¼"	2¼"–4"	3"–5⅞"
<b>Shank</b>	.082"–.092"	.099"–.148"	.120"–.148"
<b>Capacity</b>	300–350	225–300	120–225
<b>Angle/Collation</b>	15° Flat Wire Welded Coil	15° Flat Wire Welded Coil	15° Flat Wire Welded Coil
<b>Series</b>	BK, ED, EJ, EL, SE	BE, BK, BL, BT, HK, GD, GL, HD, HL, KD	HD, HK, HL, KD, MD
<b>TOOL FEATURES</b>			
<b>Tool-Free Jam Clearing</b>	Yes	Yes	Yes
<b>Depth-of-Drive</b>	No	No	No
<b>Debris Shield</b>	Yes	Yes	Yes



## DFPXP

20 Ga. 1/2" CROWN, 1/2" STAPLE  
CLINCH TOOL

ITEM #8H0001N

20<sub>GA</sub>



### Features

- High-capacity magazine — less reloading means greater productivity
- Tool-free adjustable anvil opening
- Rubber comfort grip reduces vibration, slipping and fatigue
- Bottom-load magazine for quick reloading
- 6.9" throat allows for extended reach into cartons

## F75LXP

18 Ga. 7/16" CROWN, 5/8" STAPLE  
CLINCH TOOL

ITEM #8J0002N

18<sub>GA</sub>



### Features

- High-capacity magazine — less reloading means greater productivity
- Tool-free adjustable anvil opening
- Rubber comfort grip reduces vibration, slipping and fatigue
- Bottom-load magazine for quick reloading
- 6.9" throat allows for extended reach into cartons

## F75SXP

18 Ga. 7/16" CROWN, 5/8" STAPLE  
SISAL ANVIL

ITEM #8J0001N

18<sub>GA</sub>



### Features

- High-capacity magazine — less reloading means greater productivity
- Tool-free adjustable anvil opening
- Rubber comfort grip reduces vibration, slipping and fatigue
- Bottom-load magazine for quick reloading

## Product Reference Chart

TOOL SPECS	DFPXP	F75LXP	F75SXP
<b>Trigger</b>	Sequential	Sequential	Sequential
<b>Operating Pressure</b>	65-100 psi (4-7 bar)	65-100 psi (4-7 bar)	65-100 psi (4-7 bar)
<b>Air Consumption (60 CPM)</b>	.7 scfm	.7 scfm	.8 scfm
<b>Air Inlet</b>	1/4" NPT	1/4" NPT	1/4" NPT
<b>Weight</b>	4.9 lbs (2.24 kg)	4.9 lbs (2.24 kg)	4.9 lbs (2.24 kg)
<b>Height</b>	12.9" (327 mm)	12.9" (327 mm)	12.9" (327 mm)
<b>Length</b>	14.9" (380 mm)	14.9" (380 mm)	14.9" (380 mm)
<b>Width</b>	3" (75 mm)	3" (75 mm)	3" (75 mm)
<b>Main Body Material</b>	Aluminum	Aluminum	Aluminum
<b>Warranty</b>	5 yrs	5 yrs	5 yrs
FASTENER SPECS	Fasteners are located on page 59		
<b>Gauge</b>	20	18	18
<b>Crown</b>	1/2"	7/16"	7/16"
<b>Range</b>	5/16"-5/8"	5/16"-5/8"	5/16"-5/8"
<b>Capacity</b>	230	152	152
<b>Angle/Collation</b>	Straight Glued Strip	Straight Glued Strip	Straight Glued Strip
<b>Series</b>	F	J	J
TOOL FEATURES			
<b>Tool-Free Adjustable Anvil Opening</b>	Yes	Yes	Yes
<b>Bottom-Load Magazine</b>	Yes	Yes	Yes
<b>Extended Reach Capability</b>	Yes	Yes	No

# PALLETS & CRATING FASTENERS

## 15° Smooth Shank Coil Nails

Pallets, crates, fencing, siding and underlayment

Length	Point	Finish	Coating	Collation	Box Count	Item Code
2" x .092"	Diamond	Exterior	Sencote	15° Flat Wire Welded Coil	7.2M	EJ21ADBH
2¼" x .092"	Diamond	Galv	Sencote	15° Flat Wire Welded Coil	3.6M	ED23AABH

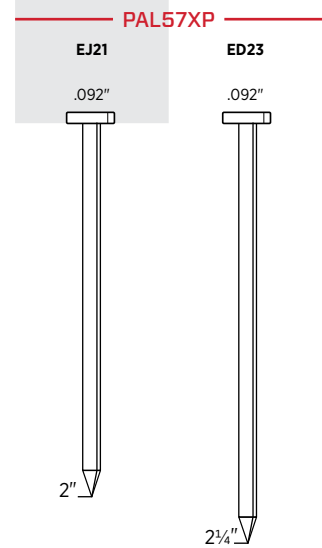

## 15° Smooth Shank Coil Nails

Pallets, framing, sheathing, subfloor, decks and trusses

Length	Point	Finish	Coating	Collation	Box Count	Item Code
2" x .113"	Diamond	Bright	Sencote	15° Flat Wire Welded Coil	6M	GD21APBF
2½" x .113"	Diamond	Bright	Sencote	15° Flat Wire Welded Coil	6M	GD25APBF
2½" x .131"	Diamond	Bright	Sencote	15° Flat Wire Welded Coil	3.6M	KD25APBF
3" x .120"	Diamond	Bright	Sencote	15° Flat Wire Welded Coil	4M	HD27APBF
3" x .131"	Diamond	Bright	Sencote	15° Flat Wire Welded Coil	3.6M	KD27APBF
3¼" x .131"	Diamond	Bright	Sencote	15° Flat Wire Welded Coil	3.6M	KD28APBF
3½" x .131"	Diamond	Bright	Sencote	15° Flat Wire Welded Coil	3.6M	KD29APBF
5" x .148"	Diamond	Bright	Sencote	15° Flat Wire Welded Coil	1.8M	MD34APBF
2" x .113"	Diamond	Galv	Sencote	15° Flat Wire Welded Coil	6M	GD21AABF
2½" x .113"	Diamond	Galv	Sencote	15° Flat Wire Welded Coil	6M	GD25AABF
3" x .131"	Diamond	Hot Dip	Sencote	15° Flat Wire Welded Coil	2.4M	KD27ASBF
3¼" x .131"	Diamond	Hot Dip	Sencote	15° Flat Wire Welded Coil	2.4M	KD28ASBF

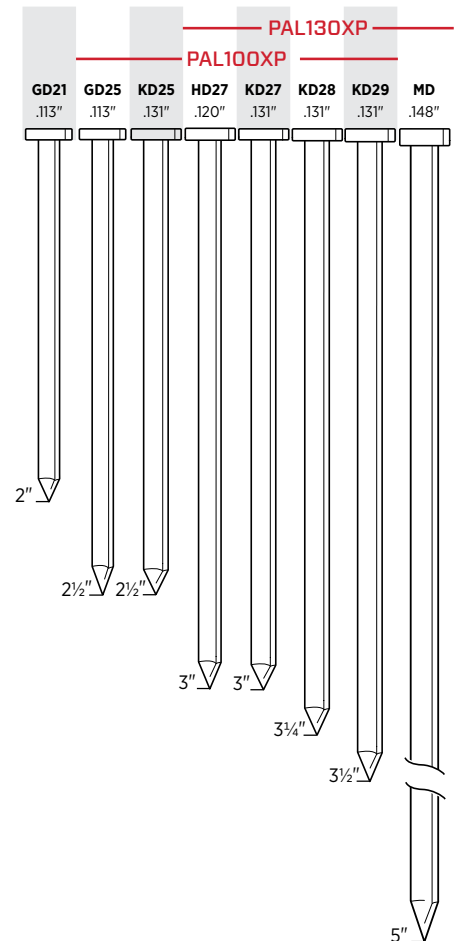

## 15° Ring Shank Coil Nails

Pallets, crates, fencing, wood shingles, siding and underlayment

Length	Point	Finish	Coating	Collation	Box Count	Item Code
1¼" x .082"	Diamond	Bright	Sencote	15° Flat Wire Welded Coil	14M	SE15APBH
1½" x .082"	Diamond	Bright	Sencote	15° Flat Wire Welded Coil	11.2M	SE17APBH
1¾" x .092"	Diamond	Hot Dip	Sencote	15° Flat Wire Welded Coil	3.6M	EL19ASBH
1⅞" x .092"	Diamond	Galv	Sencote	15° Flat Wire Welded Coil	3.6M	EL20AABH
1⅞" x .092"	Diamond	Hot Dip	Sencote	15° Flat Wire Welded Coil	3.6M	EL20ASBH
2" x .092"	Diamond	Hot Dip	Sencote	15° Flat Wire Welded Coil	3.6M	EL21ASBH
2¼" x .092"	Diamond	Galv	Sencote	15° Flat Wire Welded Coil	3.6M	EL23AABH
2¼" x .092"	Diamond	Hot Dip	Sencote	15° Flat Wire Welded Coil	3.6M	EL23ASBH
1¾" x .092"	Diamond	Stainless 304	Sencote	15° Flat Wire Welded Coil	3.6M	EL19AGBH
2" x .092"	Diamond	Stainless 304	Sencote	15° Flat Wire Welded Coil	3.6M	EL21AGBH
2¼" x .092"	Diamond	Stainless 304	Sencote	15° Flat Wire Welded Coil	3.6M	EL23AGBH

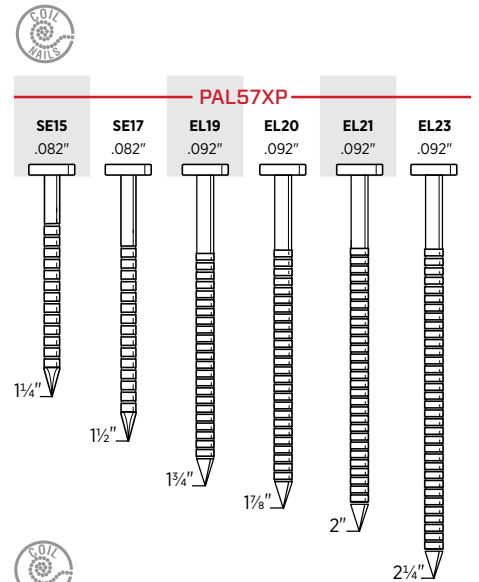

## 15° Ring Shank Coil Nails

Pallets, framing, sheathing, subfloor, decks and trusses

Length	Point	Finish	Coating	Collation	Box Count	Item Code
2" x .099"	Diamond	Bright	Sencote	15° Flat Wire Welded Coil	6.6M	BL21APBF
2" x .113"	Diamond	Bright	Sencote	15° Flat Wire Welded Coil	6M	GL21APBF
2⅝" x .113"	Diamond	Bright	Sencote	15° Flat Wire Welded Coil	6M	GL24APBF
2¼" x .099"	Diamond	Galv	Sencote	15° Flat Wire Welded Coil	6.6M	BE23AABF
2⅝" x .113"	Diamond	Hot Dip	Sencote	15° Flat Wire Welded Coil	2.7M	GL24ASBF
3" x .120"	Diamond	Hot Dip	Sencote	15° Flat Wire Welded Coil	2.4M	HL27ASBF
2⅝" x .113"	Diamond	Stainless 304	Sencote	15° Flat Wire Welded Coil	2.7M	GL24AGBF

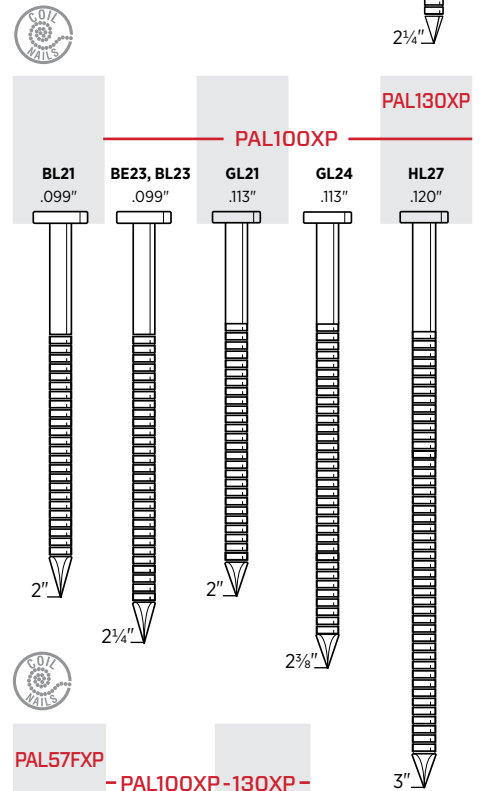

## 15° Step Ring Shank Nails

Superior fastening in subfloor applications

Length	Point	Finish	Coating	Collation	Box Count	Item Code
2" x .099"	Diamond	Bright Basic	Sencote	15° Flat Wire Welded Coil	6.6M	BT21APBF
2⅝" x .113"	Diamond	Bright Basic	Sencote	15° Flat Wire Welded Coil	4M	GT24APBF
2½" x .131"	Diamond	Bright Basic	Sencote	15° Flat Wire Welded Coil	4M	KT25APBF

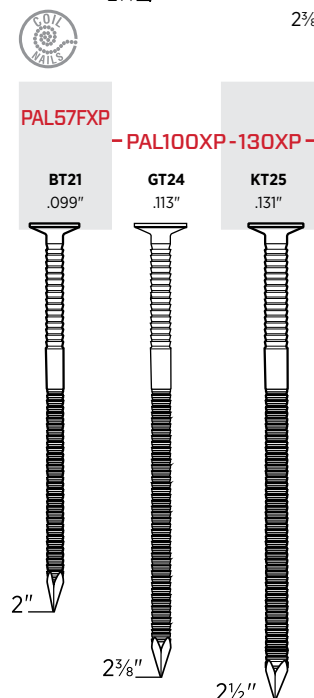

## Step Ring Pallet Coil Nails

- Superior fastening in pallet applications
- Tested and proven to reduce raised nail heads
- Unique double rings shank design reduces the potential of nail backing out

# PALLETS & CRATING FASTENERS

## 15° Screw Shank Coil Nails

Pallets, framing, sheathing, subfloor, decks and trusses

Length	Point	Finish	Coating	Collation	Box Count	Item Code
2" x .099"	Blunt Dia.	Bright	Sencote	15° Flat Wire Welded Coil	9M	BK21BPBFN
2¼" x .099"	Blunt Dia.	Bright	Sencote	15° Flat Wire Welded Coil	9M	BK23BPBFN
2½" x .099"	Blunt Dia.	Bright	Sencote	15° Flat Wire Welded Coil	6M	BK25BPBFN
3" x .120"	Diamond	Bright	Sencote	15° Flat Wire Welded Coil	4M	HK27APBFN

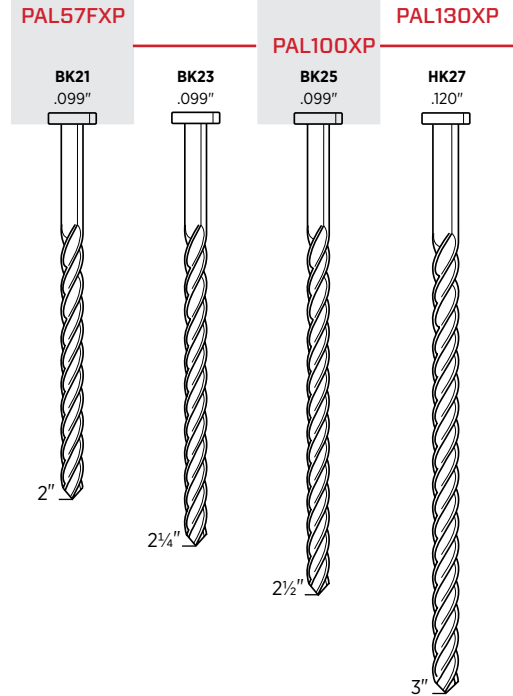

## 20<sup>GA</sup> ½" Crown Fine Wire Staples

Packaging, set-up boxes and bedding

Length	Point	Finish	Coating	Collation	Box Count	Item Code
¾"	Chisel	Galv	Sencote	Glued Strip	24M	F05BAAP
¾"	Chisel	Galv	Sencote	Glued Strip	10M	F06BAA
¾"	Chisel	Galv	Sencote	Glued Strip	24M	F06BAAP
½"	Chisel	Galv	Sencote	Glued Strip	10M	F08BAAN
½"	Chisel	Galv	Sencote	Glued Strip	15M	F08BAAP
¾"	Chisel	Stainless 304	Sencote	Glued Strip	10M	F06BGA

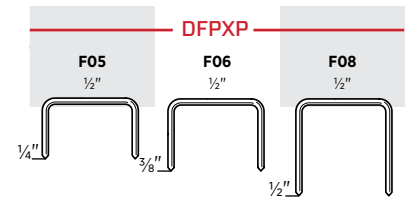

## 18<sup>GA</sup> 7/16" Crown Fine Wire Staples

For assembling packaging and joining corrugated materials

Length	Point	Finish	Coating	Collation	Box Count	Item Code
¾"	Chisel	Galv	Plain	Glued Strip	5M	J06BAA
½"	Chisel	Galv	Plain	Glued Strip	5M	J08BAAN
¾"	Chisel	Galv	Plain	Glued Strip	5M	J10BAAN

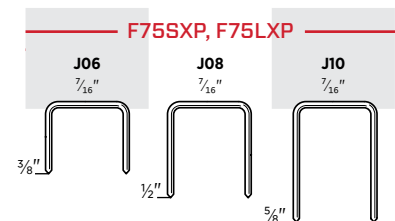



## SENCO HAS YOU COVERED

SENCO offers a range of fine and medium wire staplers for upholstery and furniture assembly. Our upholstery staplers are the most customizable in the industry, with long nosepieces, extended magazines and a wide range of fasteners for any project.

### APPLICATIONS

Upholstery, furniture assembly, cabinets, bedding, picture frames, molding, roof felt, house wrap, RV construction

### KEY FEATURES

- Lightweight
- Ergonomic
- Variety of configurations



## SFT10XP FAMILY

3/16", 3/8", 7/16", 1/2" CROWN,  
5/8" FINE WIRE STAPLERS

SFT10XP

22<sub>GA</sub>

20<sub>GA</sub>



### Features

- Heavy-duty steel cap
- Short trigger stroke
- Rear exhaust keeps oil off fabric
- Automatic models have adjustable speed triggers

#### Models and Item Codes

Crown	Ga	Staple	Description	Item Code
3/16"	22	A/D Wire	Standard	6S0001N
3/16"	22	A/D Wire	Auto	6S0101N
1/2"	22	B Wire	Standard	6S0011N
3/8"	22	C Wire	Standard	6S0021N
3/8"	22	C Wire	Auto	6S0121N
3/16"	20	E Wire	Standard	6S0031N
1/2"	20	F Wire	Standard	6S0041N
3/8"	20	G Wire	Standard	6S0051N

## SFT10XP FAMILY

3/16", 3/8", 7/16", 1/2" CROWN,  
5/8" FINE WIRE STAPLERS

DOUBLE LENGTH MAGAZINE

22<sub>GA</sub>

20<sub>GA</sub>



### Features

- Heavy-duty steel cap
- Short trigger stroke
- Rear exhaust keeps oil off fabric
- Automatic models have adjustable speed triggers

#### Models and Item Codes

Crown	Ga	Staple	Description	Item Code
1/2"	22	B Wire	Standard	6S0211N
1/2"	22	B Wire	Auto	6S0311N
3/8"	22	C Wire	Standard	6S0221N
3/8"	22	C Wire	Auto	6S0321N
1/2"	20	F Wire	Auto	6S0341N
3/8"	20	G Wire	Standard	6S0251N
7/16"	20	H Wire	Auto	6S0361N

## SFT10XP FAMILY

3/16", 3/8", 7/16", 1/2" CROWN,  
5/8" FINE WIRE STAPLERS

LONG NOSE

22<sub>GA</sub>



### Features

- Heavy-duty steel cap
- Short trigger stroke
- Rear exhaust keeps oil off fabric
- Automatic models have adjustable speed triggers

#### Models and Item Codes

Crown	Ga	Staple	Description	Item Code
3/8"	22	C Wire	Standard	6S0421N

## Product Reference Chart

TOOL SPECS	SFT10XP
<b>Trigger</b>	Sequential, Auto
<b>Operating Pressure</b>	60-95 psi (4.1-6.5 bar)
<b>Air Consumption (60 CPM)</b>	.77 scfm
<b>Air Inlet</b>	1/4" NPT
<b>Weight</b>	2.1 lbs (0.955 kg)
<b>Height</b>	6.57" (167 mm)
<b>Length</b>	8.58" (218 mm)
<b>Width</b>	1.65" (42 mm)
<b>Main Body Material</b>	Aluminum
<b>Warranty</b>	5 yrs
FASTENER SPECS	Fasteners are located on pages 63-64
<b>Gauge</b>	22, 20
<b>Crown</b>	3/16", 3/8", 7/16", 1/2"
<b>Range</b>	1/4"-5/8"
<b>Capacity</b>	110-92
<b>Angle/Collation</b>	Straight Glued Strip
<b>Series</b>	A, B, C, D, E, F, G, H



## Stapling Upholstery for Over 70 Years

SENCO® offers 18 configurations of upholstery staplers and over 40 combinations of staple length, crown and gauge.

## SFW09

3/8" CROWN, 5/8" FINE WIRE STAPLER

ITEM #4C0001N

22<sub>GA</sub>



### Features

- Rear exhaust keeps oil off fabric
- Full 1" lip length
- Rear magazine bumper protects fabric
- Rounded steel cap won't snag fabric

## NS20BXP

7/16" CROWN, HEAVY WIRE STAPLER

ITEM #9Y0001N

17<sub>GA</sub> 16<sub>GA</sub>



### Features

- 20% more powerful than the standard NS20XP for the most demanding applications
- Enhanced EZ-Clear™ latch allows for quick access to clear fasteners
- Updated aggressive locking feature
- New drive track design eliminates movement of the staple

# The NS20BXP is the Benchmark Stapler for the Furniture Industry.

- 20% more powerful than all other staplers in its class to handle even the toughest engineered woods.
- Drives both 16 and 17 gauge, 7/16" crown staples (1" to 2" in length).
- The combination of class-leading power, durability and ergonomics make it an unrivaled professional tool.



## Product Reference Chart

TOOL SPECS	SFW09	NS20BXP
<b>Trigger</b>	Dual	Contact
<b>Operating Pressure</b>	60-95 psi (4.1-6.5 bar)	70-120 psi (4.8-8.3 bar)
<b>Air Consumption (60 CPM)</b>	.77 scfm	3.98 scfm
<b>Air Inlet</b>	1/4" NPT	3/8" NPT
<b>Weight</b>	2.1 lbs (0.955 kg)	5.8 lbs (2.6 kg)
<b>Height</b>	6" (152 mm)	11" (279 mm)
<b>Length</b>	9.25" (235 mm)	15" (381 mm)
<b>Width</b>	1.63" (41 mm)	4" (102 mm)
<b>Main Body Material</b>	Aluminum	Aluminum
<b>Warranty</b>	5 yrs	5 yrs
FASTENER SPECS	Fasteners are located on pages 63, 65	
<b>Gauge</b>	22	17 (O-Wire), 16 (N-Wire)
<b>Crown</b>	3/8"	7/16"
<b>Range</b>	5/32" - 5/8"	1" - 2"
<b>Capacity</b>	110-168	160
<b>Angle/Collation</b>	Straight Glued Strip	Straight Glued/Taped Strip
<b>Series</b>	C	N, O

# UPHOLSTERY & FURNITURE FASTENERS

## 22<sup>GA</sup> 3/16" Crown Fine Wire Staples

Furniture upholstery, felt, insulation, casebacks, screening and shoes						
Length	Point	Finish	Coating	Collation	Box Count	Item Code
1/4"	Chisel	Galv	Sencote	Straight Glued Strip	10M	A04BAAN
3/8"	Chisel	Galv	Sencote	Straight Glued Strip	30M	A06BABN
3/8"	Chisel	Galv	Sencote	Straight Glued Strip	40M	A06BABP
1/2"	Chisel	Galv	Sencote	Straight Glued Strip	20M	A08BAB
1/2"	Chisel	Galv	Sencote	Straight Glued Strip	30M	A08BABP
5/8"	Chisel	Galv	Sencote	Straight Glued Strip	20M	D10BABN
5/8"	Chisel	Galv	Sencote	Straight Glued Strip	23M	D10BABPN

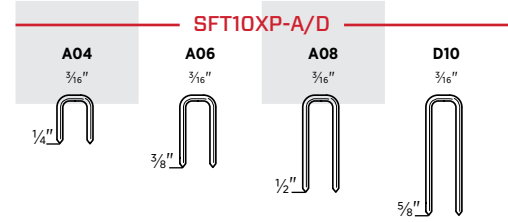

## 22<sup>GA</sup> 1/2" Crown Fine Wire Staples

Furniture upholstery, felt, insulation, casebacks, screening and shoes						
Length	Point	Finish	Coating	Collation	Box Count	Item Code
1/4"	Chisel	Galv	Plain	Straight Glued Strip	25M	B04BAAPN
3/8"	Chisel	Galv	Plain	Straight Glued Strip	40M	B06BAAP
1/2"	Chisel	Galv	Plain	Straight Glued Strip	25M	B08BAAP

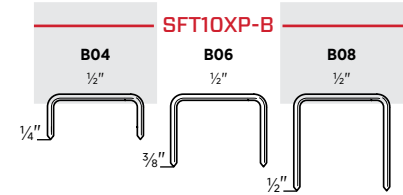

## 22<sup>GA</sup> 3/8" Crown Fine Wire Staples

Furniture upholstery, felt, insulation, casebacks, screening and shoes						
Length	Point	Finish	Coating	Collation	Box Count	Item Code
5/32"	Chisel	Galv	Plain	Straight Glued Strip	60M	C02BAAPN
3/16"	Chisel	Galv	Plain	Straight Glued Strip	55M	C03BAAPN
1/4"	Chisel	Galv	Plain	Straight Glued Strip	35M	C04BAAP
5/16"	Chisel	Galv	Plain	Straight Glued Strip	28M	C05BAAPN
3/8"	Chisel	Galv	Plain	Straight Glued Strip	50M	C06BAAP
7/16"	Chisel	Galv	Plain	Straight Glued Strip	40M	C07BAAPN
1/2"	Chisel	Galv	Plain	Straight Glued Strip	35M	C08BAAP
5/8"	Chisel	Galv	Plain	Straight Glued Strip	27M	C10BAAP
3/16"	Chisel	Stainless 304	Plain	Straight Glued Strip	25M	C03BGAN
1/4"	Chisel	Stainless 304	Plain	Straight Glued Strip	25M	C04BGAN
3/8"	Chisel	Stainless 304*	Plain	Straight Glued Strip	10M	C06BHA
3/8"	Chisel	Stainless 304	Plain	Straight Glued Strip	10M	C06BGA

\* High-Tensile 304 Stainless Steel

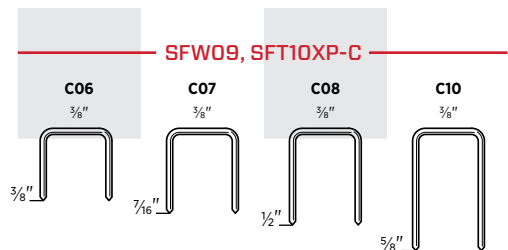
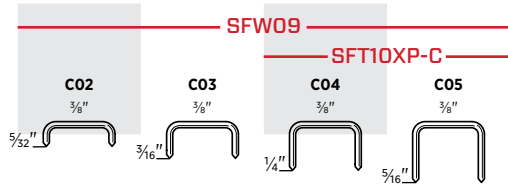

## 21<sup>GA</sup> 3/16" Crown Fine Wire Staples

Furniture upholstery, felt, insulation, casebacks, screening and shoes						
Length	Point	Finish	Coating	Collation	Box Count	Item Code
5/8"	Chisel	Galv	Sencote	Straight Glued Strip	10M	W10BAB

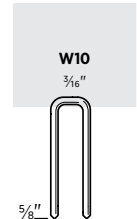



# UPHOLSTERY & FURNITURE FASTENERS

## 20<sup>GA</sup> 3/16" Crown Fine Wire Staples

Furniture upholstery, felt, insulation, casebacks, screening and shoes

Length	Point	Finish	Coating	Collation	Box Count	Item Code
3/8"	Chisel	Galv	Plain	Straight Glued Strip	10M	E06BAA
1/2"	Chisel	Galv	Plain	Straight Glued Strip	10M	E08BAA
5/8"	Chisel	Galv	Plain	Straight Glued Strip	5M	E10BAA

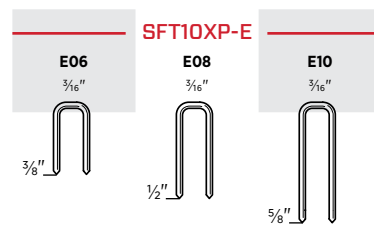

## 20<sup>GA</sup> 1/2" Crown Fine Wire Staples

Upholstery, felt, insulation and casebacks

Length	Point	Finish	Coating	Collation	Box Count	Item Code
1/4"	Chisel	Galv	Plain	Straight Glued Strip	10M	F04BAAN
1/4"	Chisel	Galv	Plain	Straight Glued Strip	17M	F04BAAP
5/16"	Chisel	Galv	Plain	Straight Glued Strip	24M	F05BAAP
3/8"	Chisel	Galv	Plain	Straight Glued Strip	10M	F06BAA
3/8"	Chisel	Galv	Plain	Straight Glued Strip	24M	F06BAAP
1/2"	Chisel	Galv	Plain	Straight Glued Strip	10M	F08BAAN
1/2"	Chisel	Galv	Plain	Straight Glued Strip	15M	F08BAAP
3/8"	Chisel	Stainless 304	Plain	Straight Glued Strip	10M	F06BGA

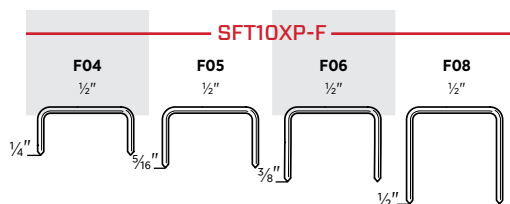

## 20<sup>GA</sup> 3/8" Crown Fine Wire Staples

Upholstery, felt, insulation and casebacks

Length	Point	Finish	Coating	Collation	Box Count	Item Code
1/4"	Chisel	Galv	Plain	Straight Glued Strip	10M	G04BAAN
3/8"	Chisel	Galv	Plain	Straight Glued Strip	5M	G06BABN
1/2"	Chisel	Galv	Plain	Straight Glued Strip	5M	G08BAB

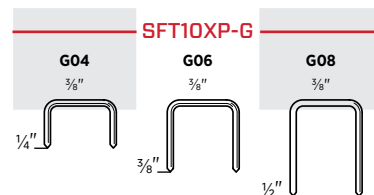

## 20<sup>GA</sup> 7/16" Crown Fine Wire Staples

Upholstery, felt, insulation and casebacks

Length	Point	Finish	Coating	Collation	Box Count	Item Code
3/8"	Chisel	Galv	Plain	Straight Glued Strip	5M	H06BAA



# UPHOLSTERY & FURNITURE FASTENERS

17<sup>GA</sup>

## 7/16" Crown Heavy Wire Staples\*

Furniture frames and crates						
Length	Point	Finish	Coating	Collation	Box Count	Item Code
1/4"	Chisel	Bright	Sencote	Glued	21.12M	O15BRBBN
1/8"	Chisel	Bright	Sencote	Glued	17.6M	O16BRBBN
1/2"	Chisel	Bright	Sencote	Glued	17.6M	O17BRBBN
1/8"	Chisel	Bright	Sencote	Glued	17.6M	O18BRBBN
1/4"	Chisel	Bright	Sencote	Glued	14.08M	O19BRBBN

\*Compatible with NS20XP, NS20BXP, SNS200XP, SNS200XP-BST, SNS41 staplers manufactured after 09/2010. SNS44XP and SNS45XP staplers manufactured after 05/2010. For older tools, order upgrade kits SNS41-YK0794, SNS44-YK0793, SNS45-FA0186.

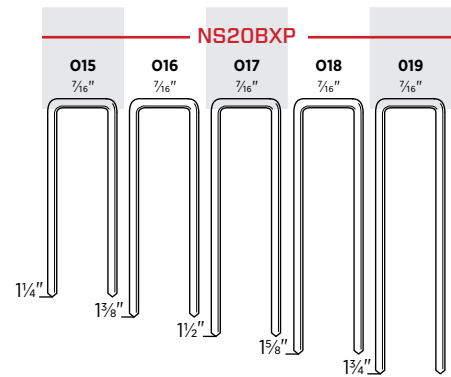

16<sup>GA</sup>

## 7/16" Crown Heavy Wire Staples

Cabinets, casebacks, drawers and upholstery						
Length	Point	Finish	Coating	Collation	Box Count	Item Code
3/4"	Chisel	Bright	Sencote	Glued	5M	N11BRB
1"	Chisel	Bright	Sencote	Glued	5M	N13BRB
1/8"	Chisel	Bright	Sencote	Taped	10M	N14BRB
1/4"	Chisel	Bright	Sencote	Taped	10M	N15BRB
1/8"	Chisel	Bright	Sencote	Taped	10M	N16BRB
1/2"	Chisel	Bright	Sencote	Taped	10M	N17BRB
1/8"	Chisel	Bright	Sencote	Taped	10M	N18BRB
1/4"	Chisel	Bright	Sencote	Taped	10M	N19BRB
2"	Chisel	Bright	Sencote	Taped	10M	N21BRB
1/2"	Chisel	Galv	Sencote	Glued	5M	N08BABN
1/2"	Chisel	Galv*	Sencote	Glued	5M	N08BBBN
1/2"	Diverg	Galv*	Sencote	Glued	5M	N08FBB
5/8"	Chisel	Galv	Sencote	Glued	5M	N10BAB
3/4"	Chisel	Galv	Sencote	Glued	5M	N11BAB
3/4"	Diverg	Galv*	Sencote	Glued	5M	N11FBB
7/8"	Chisel	Galv	Sencote	Glued	5M	N12BABN
7/8"	Diverg	Galv	Sencote	Glued	5M	N12FABN
1"	Chisel	Galv	Sencote	Glued	5M	N13BAB
1"	Diverg	Galv	Sencote	Glued	5M	N13FAB
1/8"	Chisel	Galv	Sencote	Taped	10M	N14BAB
1/4"	Chisel	Galv	Sencote	Taped	10M	N15BAB
1/4"	Diverg	Galv	Sencote	Glued	10M	N15FAB
1/8"	Chisel	Galv	Sencote	Taped	10M	N16BAB
1/2"	Chisel	Galv	Sencote	Taped	10M	N17BAB
1/8"	Chisel	Galv	Sencote	Glued	10M	N18BAB
1/4"	Chisel	Galv	Sencote	Taped	10M	N19BAB
2"	Chisel	Galv	Sencote	Taped	10M	N21BAB
1/4"	Chisel	Stainless 304	Sencote	Glued	3M	N15BGB
1/2"	Chisel	Stainless 304	Sencote	Glued	3M	N17BGB
1/4"	Chisel	Stainless 304	Sencote	Glued	3M	N19BGBN
2"	Chisel	Stainless 304	Sencote	Glued	3M	N21BGBN

\*Galvanized High-Tensile Steel

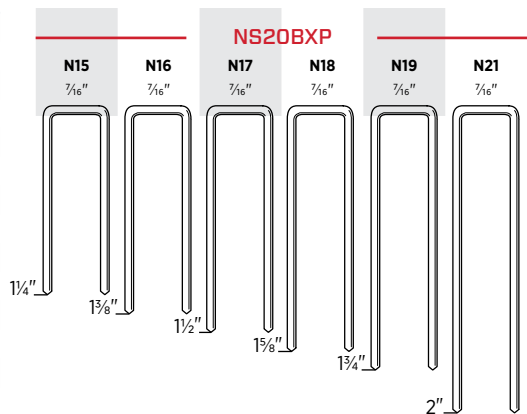
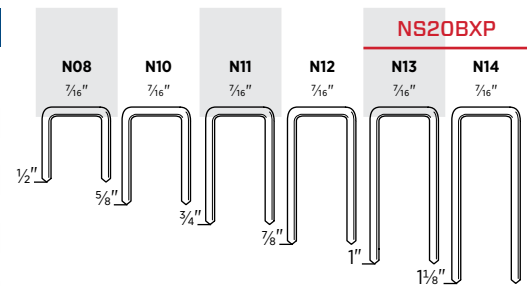

# FLOORING

## HARDWOOD FLOORING DONE RIGHT

Hardwood floors aren't so hard to install with our SHF200 stand-up flooring tool. With a long, ergonomic handle and a base that easily adjusts to any floor thickness, you will get your job done in no time. SENCO is committed to creating industry-leading flooring tools to make your job easier.



## SHF200

2" PNEUMATIC MALLET ACTUATED  
HARDWOOD FLOORING CLEAT NAILER

ITEM #8D0001N

16<sub>GA</sub>



### Features

- Innovative non-marring base that adjusts between ½" and ¾" flooring without the use of tools
- Safety trigger prevents accidental ejection of fasteners
- Lightweight and well balanced, yet 5% more powerful than competitive flooring nailers
- Extra-long ergonomic handle reduces user fatigue

## SLS20XP-HF

¾" CROWN, 1" ENGINEERED &  
HARDWOOD FLOOR STAPLER

ITEM #490021N

19<sub>GA</sub>



### Features

- Never-Lube® design — no oil required
- Front block easily adjusts to floor thickness
- Industry-exclusive safety controls staple placement
- Power-adjusted motor drives staples to consistent and controllable depth

## Product Reference Chart

TOOL SPECS	SHF200	SLS20XP-HF
<b>Trigger</b>	Sequential	Sequential
<b>Operating Pressure</b>	90-110 psi (6.2-7.6 bar)	70-120 psi (4.8-8.3 bar)
<b>Air Consumption</b> (60 CPM)	2.52 scfm	1.92 scfm
<b>Air Inlet</b>	¼" NPT	¼" NPT
<b>Weight</b>	10.1 lbs (4.58 kg)	3.2 lbs (1.5 kg)
<b>Height</b>	21.5" (546 mm)	9" (228 mm)
<b>Length</b>	17.8" (452 mm)	13" (332 mm)
<b>Width</b>	3.1" (78 mm)	3" (76 mm)
<b>Main Body Material</b>	Aluminum	Aluminum
<b>Warranty</b>	5 yrs	5 yrs
FASTENER SPECS	Fasteners are located on page 68	
<b>Gauge</b>	16	19
<b>Crown</b>	L-Head	¾"
<b>Range</b>	1 ½"-2"	⅝"-1"
<b>Capacity</b>	107	168
<b>Angled/Collation</b>	Straight Glued Strip	Straight Glued Strip
<b>Series</b>	RW	R
FLOORING MATERIAL		
<b>Hardwood</b>	Yes	Yes
<b>Hardwood Laminate</b>	Yes	Yes
<b>Board Thickness</b>	½", ⅝", ¾", ⅜" (12-26 mm)	¼", ⅝", ⅜" (6-10 mm)

**16<sub>GA</sub>**

## L-Head Flooring Cleat Nails

$\frac{1}{2}$ "<sup>1</sup>,  $\frac{5}{8}$ "<sup>2</sup>,  $\frac{3}{4}$ "<sup>3</sup>,  $\frac{7}{8}$ "<sup>4</sup> Solid hardwood flooring

Length	Point	Finish	Coating	Collation	Box Count	Item Code
1½"	Blunt Diamond	Bright	N/A	Straight Glued Strip	1M	RW17BPE
1¾"	Blunt Diamond	Bright	N/A	Straight Glued Strip	1M	RW19BPE
2"	Blunt Diamond	Bright	N/A	Straight Glued Strip	1M	RW21BPE
2"	Blunt Diamond	Stainless 304	N/A	Straight Glued Strip	1M	RW21BGE

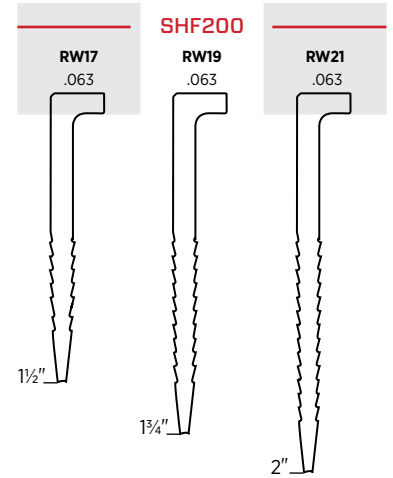

**19<sub>GA</sub>**

## 3/16" Crown Flooring Staples

$\frac{1}{4}$ "<sup>1</sup>,  $\frac{3}{8}$ "<sup>2</sup>,  $\frac{1}{2}$ "<sup>3</sup> Engineered and hardwood floors

Length	Point	Finish	Coating	Collation	Box Count	Item Code
$\frac{5}{8}$ "	Chisel	Galv	Sencote	Straight Glued Strip	5M	R10BAB
$\frac{3}{4}$ "	Chisel	Galv	Sencote	Straight Glued Strip	5M	R11BAB
1"	Chisel	Galv	Sencote	Straight Glued Strip	5M	R13BAB

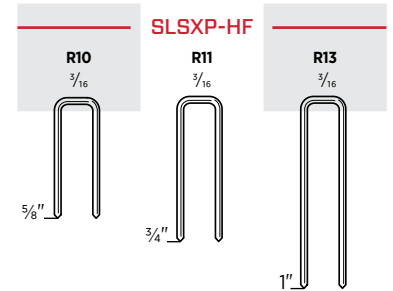



# Get the Job Done.

With genuine SENCO compressors & accessories.

SENCO continuously strives to offer a wide selection of compressors, accessories, and parts to complete our full-line of fastening systems. Our commitment is to bring you the highest quality products to help you get the job done right.



## COMPRESSORS

SENCO compressors are made to exacting standards. Only the highest quality components are used to provide the reliability expected from a SENCO product.

## AIR HOSES

SENCO offers a wide variety of air hoses that allow you to choose the right solution for your job site. Our NEW Premium Hybrid hose provides the ultimate in flexibility and memory resistance, even in extremely cold temperatures. Quick Couple Rubber Hose is the standard for the professional on the job site with its tough flexible neoprene cover. ProFlex Reinforced Polyurethane Hose is the lightest weight non-marring flexible hose. PVC is resistant to lubricating oils, chemicals, and ultraviolet sunlight.



## REGULATORS, GAUGES & LUBRICANTS

SENCO's assortments of regulators, gauges, oils and lubricants are chosen to satisfy the demanding requirements of the job site and deliver professional durability and quality. All will accurately replace the damaged component on SENCO units as well as many others.

## PLUGS & COUPLERS

SENCO quick connect coupler and plug fittings are available in the most popular Industrial Interchange styles and sizes. Quick connect couplers are also available in the Universal style to work with other style plugs.

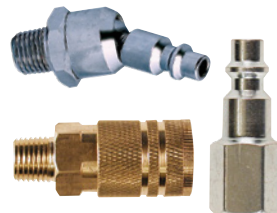

## TOOL BELT HOOKS

SENCO offers a variety of belt hooks to allow the professional the ability to use both hands without worrying about dropping their pneumatic tool.

# AIR COMPRESSORS & KITS

## THE INNOVATION YOU'VE COME TO EXPECT, THE QUALITY YOU ALREADY KNOW

Whether you need an air compressor for punch-out jobs or for all-day performance, SENCO offers high quality, reliable options to meet your needs.

### KEY FEATURES

SENCO has you covered with industry leading compressors that provide plenty of tank storage and air flow for the job site or professional shop. Many feature an oil-free pump design to reduce maintenance and have integrated panels that provide easy access to control knobs. There's even a compressor equipped with

dual couplers so you can run two hoses simultaneously. Count on quickly getting back to work - we offer compressors that have pump up times of less than 40 seconds. You can easily monitor output pressure with individual tank and outlet gauges.

A full line of hoses and accessories is also available.



## PC1131

2 HP (RUNNING) 4.3 GALLON TWIN TANK AIR COMPRESSOR



### Features

- Cast-iron cylinder for superior pump life
- Compact twin stack tank design
- Heavy-duty induction motor

## PC0968

1 HP (RUNNING) 2½ GALLON TWIN TANK FINISH AND TRIM AIR COMPRESSOR



### Features

- Compact twin stack tank design
- Lightweight — 38 lbs
- Heavy-duty induction motor

## PC1280

1½ HP (RUNNING) 6 GALLON FINISH AND TRIM AIR COMPRESSOR



### Features

- Compact and balanced pancake tank design
- Lightweight — 38 lbs
- Dual quick connect couplers

## PC1010

½ HP (RUNNING) 1 GALLON FINISH AND TRIM AIR COMPRESSOR



### Features

- Ultra-quiet — 68 dBA
- Ultra-light — 20 lbs
- Heavy-duty induction motor

## PC1010N

½ HP (RUNNING) 1 GALLON FINISH AND TRIM AIR COMPRESSOR



### Features

- Ultra-quiet — 68 dBA
- Ultra-light — 21 lbs
- Heavy-duty induction motor

## PC0947

2" FINISHPRO®18 BRAD NAILER AND PC1010 COMPRESSOR KIT



18<sub>GA</sub>

### Features

- 1 gallon PC1010 compressor
- 2" 18 gauge brad nailer
- Everything you need to get started

## Air Compressor Reference Chart

SPECS	PC1131	PC0968	PC1280	PC1010	PC1010N
<b>Motor</b>	Induction	Induction	Universal	Induction	Induction
<b>Amps</b>	14	8	12	4	4
<b>Power Source</b>	115 Volts	115 Volts	115 Volts	115 Volts	115 Volts
<b>SCFM @ 90 PSI</b>	4.4	2.2	2.8	0.7	0.7
<b>Max PSI</b>	125	135	150	135	135
<b>Weight</b>	60 lbs (27 kg)	38 lbs (17.24 kg)	38 lbs (17.24 kg)	20 lbs (9.07 kg)	21 lbs (9.53 kg)
<b>Height</b>	14.5" (368 mm)	13.5" (343 mm)	18" (457 mm)	13" (330 mm)	12.25" (311 mm)
<b>Length</b>	20.5" (521 mm)	16" (406 mm)	17" (432 mm)	14" (356 mm)	11.5" (292 mm)
<b>Width</b>	16.5" (419 mm)	15" (381 mm)	16.3" (414 mm)	10" (254 mm)	14" (356 mm)
<b>Warranty</b>	1 yr	1 yr	1 yr	1 yr	1 yr
FEATURES					
<b>Thermal Over-load Protector</b>	Yes	Yes	Yes	Yes	Yes
<b>Pump</b>	Oil-Lube	Oil-Free	Oil-Free	Oil-Free	Oil-Free
<b>Pump Up/Recovery Time</b>	67 sec./16 sec.	82 sec./17 sec.	152 sec./33 sec.	125 sec./30 sec.	125 sec./30 sec.
<b>¼" Quick Connect Coupler</b>	1	1	2 (Dual)	1	1
<b>Regulator</b>	Yes	Yes	Yes	Yes	Yes
<b>Individual Tank &amp; Outlet Gauges</b>	Yes	Yes	Yes	Yes	Yes
<b>Cold Start Valve</b>	Yes	No	No	No	No
<b>CSA Approved</b>	Yes	Yes	Yes	Yes	Yes

## Tool Kit Ref. Chart

KIT SPECS	PC0947
<b>Compressor</b>	PC1010
<b>Tool</b>	FinishPro® 18
<b>Trigger</b>	Contact
<b>Tool Operating Pressure</b>	70-95 psi
<b>Tool Air Inlet</b>	¼" NPT
<b>Tool Weight</b>	3 lbs (1.6 kg)
<b>Tool Height</b>	9.3" (238 mm)
<b>Tool Length</b>	9.75" (248 mm)
<b>Kit Warranty</b>	1 yr
<b>Coil Hose</b>	¼" x 25'
<b>Air Fittings</b>	Yes
<b>Tool Oil &amp; Safety Glasses</b>	Yes
<b>Variety Pack of Fasteners</b>	18 Ga. Brads
FASTENERS	
<b>Gauge</b>	18 Ga. Brads
<b>Range</b>	⅝"-2"



# ACCESSORIES

## FILTERS, REGULATORS, LUBRICANTS, PLUGS, COUPLERS, HOSES, PART KITS AND MORE

SENCO offers an assortment of accessories that are precision engineered to meet the demanding requirements of professionals. Be sure that your tools and compressors are running at peak performance by using SENCO certified replacement parts, accessories, hoses, oils and lubricants.



## Air Hoses

SENCO offers a wide variety of air hoses in various materials, sizes and specifications for your job site.

(FPT) - Female Pipe Thread  
(MPT) - Male Pipe Thread

### Quick Couple Rubber Hose

SENCO's premium air hoses:

- Can handle up to 250 psi working pressure
- Oil-resistant nitrile tube
- Braided textile reinforcing for max strength and kink resistance
- Remains flexible at temperatures from -40° to 200°F
- 4-to-1 working pressure to burst safety factor
- Tough, flexible neoprene cover

	Hose Size	Length	Qty.	ITEM #
Gray with Industrial Interchange Plug and Coupler Fittings	¼"	50 ft	1	PC0064
Gray with Industrial Interchange Plug and Coupler Fittings	¼"	100 ft	1	PC1152
Gray with Industrial Interchange Plug and Coupler Fittings	¾"	50 ft	1	PC0065



GRAY WITH PLUG & COUPLER  
PC0064, PC1152,  
PC0065

### ProFlex™ Reinforced Polyurethane Red Air Hose

Lightest available non-marring flexible hose

- Flexible in all weather (-48° to 150°F)
- Working pressure: 250 psi
- Durable — oil and fuel resistant
- MPT-threaded ends

Description	Hose Size	Length	Qty.	ITEM #
ProFlex™ with MPT Ends (Use with FPT-Type Fittings)	¼"	50 ft	1	PC0977
ProFlex™ with MPT Ends (Use with FPT-Type Fittings)	¼"	100 ft	1	PC0978
ProFlex™ with MPT Ends (Use with FPT-Type Fittings)	¾"	50 ft	1	PC0979



PROFLEX WITH MPT ENDS  
PC0977, PC0978,  
PC0979

### Premium Hybrid Polymer Air Hose

- Provides the ultimate in flexibility and memory resistance, even in extreme cold
- Offers the best combination of strength and flexibility on the market

Description	Hose Size	Length	Qty.	ITEM #
Hybrid with MPT Ends (Use with FPT-Type Fittings)	¼"	50 ft	1	PC1319
Hybrid with MPT Ends (Use with FPT-Type Fittings)	¼"	100 ft	1	PC1320
Hybrid Field-Repairable with MPT Ends (Use with FPT-Type Fittings)	¼"	50 ft	1	PC1321
Hybrid Field-Repairable with MPT Ends (Use with FPT-Type Fittings)	¼"	100 ft	1	PC1322
Hybrid Field-Repairable with MPT Ends (Use with FPT-Type Fittings)	¾"	50 ft	1	PC1339



HYBRID WITH MPT ENDS  
PC1319, PC1320

### Field Repairable End Fitting

- Field repairable hose ends are made with aircraft aluminum for easy on-site repair without hose clamps

Description	Hose Size	Qty.	ITEM #
Hybrid Hose Repair End Fitting	¼"	1	PC1341
Hybrid Hose Repair End Fitting	¾"	1	PC1337
Hybrid Hose Splicer	¼"	1	PC1338
Hybrid Hose Splicer	¾"	1	PC1340



HYBRID HOSE FIELD REPAIR KITS  
END FITTING AND HOSE SPLICER KITS



## Plugs & Couplers

Quick connect plugs and couplers are available in the most popular Industrial Interchange styles. Couplers are also available in Universal style.

### Universal Couplers — push plug into coupler (no need to pull back on sleeve)

Type	Body Size	NPT Size	Pack Qty.	ITEM #
Female	¼"	¼" FPT	1	PC0900

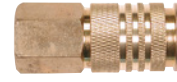

FEMALE COUPLER  
PC0900

### Plugs — Industrial Interchange

Type	Body Size	Size	Pack Qty.	ITEM #
Male	¼"	¼" MPT	2	PC0479
Male	¼"	⅜" MPT	2	PC0480
Female	¼"	¼" FPT	2	PC0477
Female	¼"	⅜" FPT	2	PC0478
Push-on Barb	¼"	¼" LHB	1	PC0576
Push-on Barb	¼"	⅜" LHB	1	PC0577



MALE PLUG  
PC0479, PC0480



FEMALE PLUG  
PC0477,  
PC0478



PLUG (PUSH-ON LOCKING BARB)  
PC0576, PC0577

### Couplers — Industrial Interchange

Type	Body Size	Size	Pack Qty.	ITEM #
Male	¼"	¼" MPT	1	PC0503
Male	¼"	⅜" MPT	1	PC0504
Female	¼"	¼" FPT	1	PC0501
Female	¼"	⅜" FPT	1	PC0502
Push-on Barb	¼"	¼" LHB	1	PC0505
Push-on Barb	¼"	⅜" LHB	1	PC0506



MALE COUPLER  
PC0503, PC504



FEMALE COUPLER  
PC0501, PC0502



COUPLER  
(PUSH-ON LOCKING BARB)  
PC0505, PC0506

## Swivel Plugs & Couplers

- Allow easier access when working in corners and tight spaces
- Reduce fatigue
- Help prevent kinks and reduce stress on hose
- Provide strong and simple connection for pneumatic tools

### Swivel Plugs — Industrial Interchange

Type	Body Size	NPT Size	Pack Qty.	ITEM #
Male	¼"	¼" MPT	2	PC1323
Male	¼"	⅜" MPT	2	PC1325



MALE SWIVEL PLUG  
PC1323, PC1325

### Swivel Couplers — Industrial Interchange

Type	Body Size	NPT Size	Pack Qty.	ITEM #
Female	¼"	¼" FPT	1	PC1328



FEMALE SWIVEL COUPLER  
PC1328

### Swivel Couplers — Universal

Type	Body Size	NPT Size	Pack Qty.	ITEM #
Female	¼"	¼" FPT	1	PC1330



FEMALE SWIVEL COUPLER  
PC1330

(FPT) - Female Pipe Thread  
(MPT) - Male Pipe Thread  
(LHB) - Locking Hose Barb, no clamp required when used with SENCO Quick Couple Hose.

## Air Hose Accessories

Splicer				
Description	Size	Pack Qty.	ITEM #	
Push-On Barbed Hose Splicer	¼" LHB	2	PC0643	



ProFlex Hose Fittings				
Description	Size	Pack Qty.	ITEM #	
Brass Hose End	¼" MPT	1	PC0983	
Brass Hose End and Splicer	¼" MPT	1	PC0987	



## Air Hose and Compressor Accessories

Tripod Manifold				
Description	Inlet Thread	Outlet Thread	Pack Qty.	ITEM #
3-Way Flat Manifold Industrial Interchange	¼" Plug	¼" Coupler	1	PC1138



Blow Gun				
Description	Inlet Thread	Pack Qty.	ITEM #	
Air Blow Gun	¼" FPT	1	PC0489	

(FPT) - Female Pipe Thread



Teflon® Thread Sealing Tape			
Description	Pack Qty.	ITEM #	
½" x 260' Sealing Tape	1	PC0349	



## Regulators & Gauges

SENCO's assortment of filters and gauges are precision engineered to meet the demanding requirements of professional contractors. Be sure that your compressor is running at peak performance by using SENCO-certified replacement parts and accessories.

Air Regulation Accessories: Regulator with Gauge					
Description	Max PSI	Max Airflow	FPT Size	NPT Gauge	ITEM #
Mini Regulator with Gauge	250	14 SCFM	¼"	⅛"	PC0656
Regulator with Gauge	300	80 SCFM	⅜"	⅛"	PC0657
Back-Mount Pressure Gauge	160	—	—	⅛"	PC0057
Back-Mount Pressure Gauge	160	—	—	¼"	PC0051



## Oils & Lubricants

Oils and Lubricants				
Description	Features	Size	Case Qty.	ITEM #
Pneumatic Tool Oil (½ pt)	<ul style="list-style-type: none"> <li>Premium-grade oil with high-quality paraffin distillate stock</li> <li>Contains a carefully balanced rust and oxidation inhibitor with an effective anti-foaming additive</li> </ul>	8 oz	12	PC0101
Pneumatic Tool Oil (1 qt)	<ul style="list-style-type: none"> <li>Premium-grade oil with high-quality paraffin distillate stock</li> <li>Contains a carefully balanced rust and oxidation inhibitor with an effective anti-foaming additive</li> </ul>	32 oz	12	PC0102
Pneumatic Tool Oil (1 gal)	<ul style="list-style-type: none"> <li>Premium-grade oil with high-quality paraffin distillate stock</li> <li>Contains a carefully balanced rust and oxidation inhibitor with an effective anti-foaming additive</li> </ul>	128 oz	4	PC0103
Compressor Pump Oil (1 qt)	<ul style="list-style-type: none"> <li>Premium-grade oil with high-quality naphthenic distillate stock</li> <li>Recommended for all oil-splash compressors</li> <li>Protects against corrosion</li> <li>Lubricates to extend part life</li> </ul>	32 oz	12	PC0344
Moisture Shield Tool Lubricant (1 qt)	<ul style="list-style-type: none"> <li>For use in cold weather and/or high-moisture areas</li> <li>Protects against corrosion</li> <li>Lubricates to extend part life</li> <li>Special additive to minimize exhaust fog</li> </ul>	32 oz	12	PC1295
Tool Lubricant	<ul style="list-style-type: none"> <li>Protects against corrosion</li> <li>Lubricates to extend part life</li> <li>Special additive to minimize exhaust fog</li> </ul>	4 oz	12	YB0123



PNEUMATIC TOOL OILS  
 ½ pt PC0101      1 qt PC0102      1 gal PC0103



COMPRESSOR PUMP OIL PC0344      MOISTURE SHIELD TOOL LUBRICANT PC1295      TOOL LUBRICANT YB0123

## Safety Glasses & Tool Belt Hooks

Safety Glasses		
Description	Qty.	ITEM #
Wrap-Around Safety Glasses*	10-Case	PC1166

\*Filters 99% of UVA and UVB rays. Meets or exceeds ANSI Z87.1 and CE EN 166 safety standards. For indoor and outdoor use.



WRAP AROUND PC1166

Tool Belt Hooks			
Description	Size	Qty.	ITEM #
Attaches to ¼" Air Fitting on Tool	Standard	1	PC0350
Attaches to ¼" Air Fitting on Tool	X-Wide	1	PC0629
Attaches to ⅜" Air Fitting on Tool	Standard	1	PC0351
Attaches to ⅜" Air Fitting on Tool	X-Wide	1	PC0630



BELT HOOK PC0350



BELT HOOK PC0629



BELT HOOK PC0351



BELT HOOK PC0630

## Li-Ion Batteries

For use with 18V Li-Ion DuraSpin and SENCO FUSION tools		
18V Li-Ion Battery 1.5 amp hour	For use with	
VB0155	DS222-18V DS225-18V DS322-18V F-15XP F-16XP F-18XP F-LXP F-35XP* F-35FRHXP*	 <ul style="list-style-type: none"> <li>• 1.5 amp hour</li> <li>• High-quality reliable cells</li> <li>• Longer storage life</li> <li>• Charges to 80% in 15 minutes</li> </ul>
18V Li-Ion Battery 3.0 amp hour		
VB0190		 <ul style="list-style-type: none"> <li>• 3.0 amp hour</li> <li>• State of the art 21700 cells</li> <li>• Longer storage life</li> <li>• Drives more than 2X the fasteners as VB0155 (above)</li> </ul>

\*For optimal performance only use the VB0190 battery with the F-35XP and F-35FRHXP

## Battery Chargers

For use with SENCO batteries		
Battery Charger	For use with	
VB0156	VB0155 VB0190**	 <ul style="list-style-type: none"> <li>• 3 amp quick charger</li> <li>• Battery charge indicators display charge status of your battery</li> </ul>
Battery Charger	For use with	
VB0189	VB0155 VB0190	 <ul style="list-style-type: none"> <li>• 5 amp quick charger</li> <li>• Upright design is ideal for wall mounting</li> </ul>

\*\*The VB0189 charger is recommended for the VB0190 battery; using the VB0156 charger will result in longer charge times.

## Replacement No-Mar Pads



Replacement No-Mar Pads Fit	ITEM #
AF25, CF25	HF0064
AF41, CF41	HF0079
FIP11	HC0463
FIP15, FIP18	HC0506
FIP15Mg, FIP18Mg	HC0571
FIP23SXP, 23LXP, 21LXP	HC0729
FIP25XP	HF0064
FIP32*	HC0396
FIP32*	HC0401
FIP41XP, FIP42XP	HF0079
FN55AX	HF0113
FN65DA	HF0110
FP600-650 SERIES	HF0046, HC0253
FP601, FP602, FP651, FP652	HA0170
FP700 SERIES	HF0046, HC0253

One pad per pack.

\*Refer to parts chart to identify desired safety element design.

Replacement No-Mar Pads Fit	ITEM #
GT65DA	HC0626
GT65RHA	HC0625
GT90CH	HA0200
GT90FRH	HA0201
SCN49	HC0536
SFN30, SFN40, SFNI	HF0079
SLS15, SLS18	HC0507
SLS15Mg, SLS18Mg	HC0572
SLS20, SLS20XP (K, L & R CROWNS)	HF0028
SLS20, SLS20XP (M CROWN)	HF0029
SLS25-L, SLS25XP-L	HF0028

One pad per pack.

## Maintaining Your Tools

SENCO repair kits are designed to provide the parts normally needed to properly maintain and service your SENCO tools.



Tool Model	Description	Item Code
FinishPro15, 18, 2N1	Repair Kit	YK0393
FinishPro15Mg, 18Mg	Repair Kit	YK0780
FinishPro16XP	Repair Kit A	YK0884
FinishPro16XP	Repair Kit B	YK0885
FinishPro18BMg	Repair Kit	YK0868
FinishPro21LXP, 23LXP	Repair Kit	YK0855
FinishPro23SXP	Repair Kit	YK0854
FinishPro25XP	Firing System Kit	YK0281
FinishPro25XP	Piston Stop Kit	YK0282
FinishPro32	Repair Kit	YK0394
FinishPro33Mg	Repair Kit	YK0787
FinishPro35Mg	Repair Kit	YK0788
FinishPro41XP, 42XP	Firing System Kit	YK0361
FinishPro41XP, 42XP	Piston Stop Kit	YK0362
FramePro601, 602, 651, 652	Repair Kit	YK0360
FramePro XP 701, 752, 702, 752	Firing System Kit	YK0243
FramePro XP 701, 752, 702, 752	Piston Stop Kit	YK0244
HN150, HN250	Repair Kit	BA0158
JoistPro150XP	Firing System Kit	YK0823
JoistPro150XP	Piston Stop Kit	YK0824
JoistPro250XP	Firing System Kit	YK0825
JoistPro250XP	Piston Stop Kit	YK0826
JoistPro250XP	Safety Upgrade Kit	YK0869
LS1XP	Repair Kit	YK0858
MW	Repair Kit	YK0371
NS20XP	Firing System Kit	YK0840
NS20XP	Piston Stop Kit	YK0841
NS20XP	Siding Safety Kit	HC0788
NS20BXP	Firing System Kit	YK0838
NS20BXP	Piston Stop Kit	YK0839
PAL57FXP	Repair Kit	YK0446
PS15XP, PS15RXP	Repair Kit	YK0784
PS15XP, PS15RXP	Repair Kit	YK0818
PS15XP, PS15RXP	Block Out Kit	YK883
PS15XP	Retrofit Kit – Solid Safety	YJ0044
PS15RXP	Retrofit Kit – Solid Safety	YJ0049
PS20XP	Repair Kit	YK0783
RoofPro™ 455XP	Firing System Kit	YK0424
RoofPro™ 445XP	Repair Kit	YK0865
RoofPro™ 445XP	Wear Guard Kit	YK0870
RoofPro™ 445XP	Gate Repair Kit	YK0871
RoofPro™ 455XP	Piston Stop Kit	YK0425
RoofPro™ 450XP	Repair Kit	YK0426
SC 1	Repair Kit	YK0370
SC 2	Repair Kit	YK0371
SCN48	Repair Kit	YK0769
SCN49	Repair Kit	YK0771
SCN60, SCN65	Seal Kit	YK0366

Tool Model	Description	Item Code
SFN1, SKS, SPS	Repair Kit	YK0376
SFN1, SKS, SPS	Retrofit Kit	YJ0035
SFN30	Repair Kit	YK0368
SFT10XP, SFT10XP D/L, SFT10XP LN	Piston Stop Kit	YK0802
SFT10XP, SFT10XP D/L, SFT10XP LN	Firing System Kit	YK0803
SFT10XP (AUTO)	Firing System Kit	YK0804
SFT10XP (AUTO D/L)	Firing System Kit	YK0804
SFT10XP (AUTO D/L)	Piston Stop Kit	YK0802
SFN1, SKSXP, SPS	Firing System Kit	YK0804
SFW09	Repair Kit	YK0775
SFW10XP	Piston Stop Kit	YK0321
SFW10XP	Firing System Kit	YK0322
SLP20	Repair Kit	YK0373
SLS15, SLS18	Repair Kit	YK0393
SLS15Mg, SLS18Mg	Repair Kit	YK0780
SLS20XP	Repair Kit	YK0372
SLS25XP	Piston Stop Kit	YK0291
SLS25XP	Firing System Kit	YK0359
SLS150Mg	Repair Kit	YK0852
SCP40XP	Firing System Kit	YK0444
SCP40XP	Piston Stop Kit	YK0445
SN901/902XP, FP325/325FRHXP	Firing System Kit	YK0444
SN901/902XP, FP325/325FRHXP	Piston Stop Kit	YK0445
SN951XP, SN952XP	Firing System Kit	YK0444
SN951XP, SN952XP	Piston Stop Kit	YK0768
SNS40	Repair Kit	YK0374
SNS41	Repair Kit	YK0423
SNS41 (Retrofit Kit)	Cap/Firing Valve	YJ0034
SNS41	Driver/Back Plate Upgrade	YK0794
SNS44XP	Firing System Kit	YK0421
SNS44XP	Piston Stop Kit	YK0422
SNS44XP	Driver/Back Plate Upgrade	YK0793
SNS45XP	Piston Stop Kit	YK0231
SNS50XP, SQS55XP	Seal Kit	YK0375
SNS200XP-BST	Firing System Kit	YK0838
SNS200XP-BST	Piston Stop Kit	YK0839
SNS200XP-BST	Wider Driver Kit	YK0873
SNS200XP	Firing System Kit	YK0840
SNS200XP	Piston Stop Kit	YK0841
SNS200XP	Block-Out Kit	YK0850
SNS200XP	Wider Driver Kit	YK0872
SNS200XP	Siding Safety Kit	HC0748
TN11G1	Repair Kit	YK0888
TN11L1, TN21L1	Repair Kit	YK0889
WC200XP	Piston Stop Kit	YK0784
WC200XP	Repair Kit	YK0783
WC200XP	Block-Out Kit	YK0786
WC200XP	Retrofit Kit - Solid Safety	YJ0037

Download SENCO tool parts charts at [www.senco.com](http://www.senco.com) to see a complete list of available individual parts.



## BRIGHT BASIC

Bright Basic fasteners are an uncoated steel, which is commonly used in applications where corrosion protection is not required such as interior framing, finish and trim. These fasteners are not recommended for use in treated lumber or exterior applications.



**GOOD**  
CORROSION  
RESISTANCE

## ELECTRO GALVANIZED

Electro Galvanized fasteners have a thin layer of zinc coating that helps corrosion resistance in mild weather conditions and in areas with lower humidity. Because of its minimal protective properties these fasteners are recommended for interior use in areas such as kitchens and bathrooms.



**GOOD**  
CORROSION  
RESISTANCE

## HOT DIPPED GALVANIZED

Hot Dipped Galvanized nails have one ounce per square foot of zinc coating. The zinc coating on the nail acts as a barrier between the base steel and the elements, slowing the corrosion process. Ideal for preservative-treated wood and most exterior applications.



**BETTER**  
CORROSION  
RESISTANCE

## 304 STAINLESS STEEL

304 Stainless Steel contains 18% chromium and 8% nickel among other elements, making it resist most oxidizing acids and rust. An excellent choice for all types of environments and woods including exotic woods, cedar or redwood.

Recommended use: Exposure to wet conditions regularly and more than 5 miles away from a body of water.



**BEST**  
CORROSION  
RESISTANCE

## BOX, CARTON &amp; PALLET QUANTITIES - FASTENERS

## Nails

Item Code	Boxes Per Carton	Boxes Per Skid
A100509	5	900
A100629	5	900
A100759	5	900
A101009	5	900
A101259	5	900
A101379	5	900
A101509	5	900
A102009	5	900
A109809	5	900
A109909	5	900
A201009	5	700
A201259	5	700
A201509	5	700
A202009	5	700
A209809	5	700
A209909	5	700
A301500	5	480
A301750	5	480
A302000	5	480
A302009	5	480
A302500	5	480
A302509	5	480
A402009	5	480
AX10EAA	16	480
AX11EAA	16	480
AX13EAA	10	300
AX15EAA	10	300
AX17EAA	8	240
AX18EAA	8	240
AX19EAA	6	180
AX21EAA	6	180
AX22EAA	6	180
AY10EAA	16	480
AY11EAA	16	480
AY13EAA	10	300
AZ08EAA	32	960
AZ11EAA	24	720
AZ13EAA	16	480
BD17APBC	N/A*	24
BE23AABF	N/A*	45
BG17AAAQ	N/A*	40
BG18AAAQ	N/A*	40
BK21BPPFN	N/A*	35
BK23BPPFN	N/A*	35
BK25BPPFN	N/A*	35
BL21APBF	N/A*	45
BT21APBF	N/A*	45
CZ08EAA	N/A*	140
CZ10EAA	24	1440
CZ10EAA	N/A*	140
CZ11EAA	24	1152
CZ11EAA	N/A*	140
CZ13EAA	12	720
CZ15EAA	12	720
CZ16EAA	12	720
CZ17EAA	12	720
CZ21EAA	12	576
DA13EPBN	5	200
DA15AIA	5	200
DA15EABN	5	200
DA15EPBN	5	200
DA17AIA	5	200
DA17EABN	5	200
DA17EPBN	5	200
DA19AIA	4	160
DA19EABN	4	160
DA19EPBN	4	160
DA21EABN	4	160
DA21EGBN	N/A*	90
DA21EPBN	4	160
DA23EPBN	3	120

## Nails (cont.)

Item Code	Boxes Per Carton	Boxes Per Skid
DA25EAB	3	120
DA25EGB	N/A*	80
DA25EPB	3	120
ED23AABH	N/A*	60
EJ21ADBH	N/A*	40
EJ23ADBH	N/A*	40
EJ23ASBC	N/A*	24
EL19AGBH	N/A*	60
EL19ASBH	N/A*	60
EL20AABH	N/A*	60
EL20ASBH	N/A*	60
EL21AGBH	N/A*	60
EL21ASBH	N/A*	60
EL23AABH	N/A*	60
EL23AGBH	N/A*	60
EL23ASBC	N/A*	24
EL23ASBH	N/A*	60
G524APBXN	N/A*	72
G524ASBXN	N/A*	72
G621ASBXN	N/A*	80
G624APBXN	N/A*	72
G624ASBXN	N/A*	72
GC21APBX	N/A*	80
GC23AHAK	N/A*	80
GC24APBX	N/A*	72
GC24ASBX	N/A*	72
GC25APBX	N/A*	72
GD21AABF	N/A*	40
GD21APBF	N/A*	40
GD24APBSN	N/A*	48
GD24ASBS	N/A*	45
GD25AABF	N/A*	40
GD25AABS	N/A*	48
GD25APBF	N/A*	40
GD25APBSN	N/A*	48
GE21APAX	N/A*	80
GE21ASBX	N/A*	80
GE24AGBK	N/A*	80
GE24APBX	N/A*	72
GE24ASBX	N/A*	72
GL21APBF	N/A*	40
GL21APBSN	N/A*	48
GL21ASBS	N/A*	45
GL24AABS	N/A*	48
GL24AGBF	N/A*	24
GL24AGBS	N/A*	72
GL24APBF	N/A*	40
GL24APBSN	N/A*	48
GL24ASBF	N/A*	40
GL24ASBS	N/A*	45
GT24APBF	N/A*	40
H527APBXN	N/A*	48
H528APBXN	N/A*	48
H627APBXN	N/A*	48
H627ASBXN	N/A*	48
HC27APBX	N/A*	48
HC27ASBX	N/A*	48
HC28APBX	N/A*	48
HD27APBF	N/A*	40
HD27APBSN	N/A*	48
HE27ASBX	N/A*	48
HF27EDB	N/A*	80
HF27EPAK	N/A*	40
HJ25ADBS	N/A*	45
HK27APBFN	N/A*	35
HL27AGBS	N/A*	54
HL27ASBF	N/A*	40
HL27ASBS	N/A*	40
HR22APAF	N/A*	40
HR74APAF	N/A*	40
K525APBXN	N/A*	72

## Nails (cont.)

Item Code	Boxes Per Carton	Boxes Per Skid
K527APBXN	N/A*	48
K527APBXR	N/A*	80
K527ASBXN	N/A*	48
K528APBXN	N/A*	48
K528APBXR	N/A*	80
K528ASBXN	N/A*	48
K529APBXN	N/A*	48
K627ASBXN	N/A*	48
K628APBXN	N/A*	48
K628ASBXN	N/A*	48
K629ASBXN	N/A*	48
KC27AGBK	N/A*	80
KC27APBX	N/A*	48
KC27ASBX	N/A*	48
KC28AGBK	N/A*	80
KC28APBX	N/A*	48
KC28ASBX	N/A*	48
KC29APBX	N/A*	48
KC29ASBX	N/A*	48
KC31APBX	N/A*	40
KD25AABS	N/A*	45
KD25APBF	N/A*	40
KD25APBSN	N/A*	48
KD27APBF	N/A*	40
KD27APBSN	N/A*	48
KD27ASBF	N/A*	24
KD27ASBS	N/A*	40
KD28AGBS	N/A*	54
KD28APBF	N/A*	40
KD28APBSN	N/A*	48
KD28ASBF	N/A*	45
KD28ASBS	N/A*	40
KD29APBF	N/A*	40
KD29APBSN	N/A*	48
KD29ASBS	N/A*	40
KJ17AEBD	N/A*	100
KJ17AHBD	3	900
KT25APBF	N/A*	40
LC29APBX	N/A*	48
M001000	20	960
M001001	16	768
M001002	6	480
M001003	6	480
M001004	6	384
M001005	6	384
M001007	6	288
M002261	N/A*	100
M002262	N/A*	100
M002263	N/A*	100
M002264	N/A*	100
M002265	N/A*	100
M002266	N/A*	100
M003011	N/A*	24
M003101	N/A*	56
M003103	N/A*	56
M003104	N/A*	48
M003105	N/A*	40
M003106	N/A*	40
MD17AJBDN	N/A*	96
MD17AQBD	N/A*	96
MD25AHBD	N/A*	100
MD25AJBDN	N/A*	96
MD25AQBDN	N/A*	96
MD27APBSN	N/A*	36
MD28APBSN	N/A*	36
MD34APBF	N/A*	36
ND25AJBDN	N/A*	96
ND25AQBDN	N/A*	96
RW17BPE	10	510
RW19BPE	10	510
RW21BGE	10	510

## Nails (cont.)

Item Code	Boxes Per Carton	Boxes Per Skid
RW21BPE	10	510
SE15APB	N/A*	40
SE15APBH	N/A*	40
SE17APBH	N/A*	40
SE19APB	N/A*	40
W3050YXS	5	250
W3075YXC	5	250
W3100YXC	5	250
W3125YXC	5	250
W3150YXC	5	250
ZX10EAA	12	720
ZX13EAA	12	576
ZX16EAA	10	360
ZX18EAA	10	360
ZX21EAA	10	240

## Staples

Item Code	Boxes Per Carton	Boxes Per Skid
A04BAAN	48	1152
A06BABN	6	216
A06BABP	8	192
A08BAB	12	288
A08BABP	8	192
A800629	5	600
A800759	5	600
A801009	5	600
A801259	5	600
A801509	5	600
A809909	5	600
B04BAAPN	8	192
B06BAAP	4	96
B08BAAP	4	96
C02BAAPN	8	192
C03BAAPN	8	192
C03BGAN	8	272
C04BAAP	8	192
C04BGAN	8	272
C05BAAPN	8	192
C06BAAP	4	96
C06BGA	20	480
C06BHA	20	640
C07BAAPN	4	96
C08BAAP	4	96
C10BAAP	4	96
D10BABN	6	216
D10BABPN	8	192
E06BAA	20	640
E08BAA	16	512
E10BAA	25	800
F04BAAN	12	384
F04BAAP	8	192
F05BAAP	4	96
F06BAA	10	300
F06BAAP	4	96
F06BGA	10	300
F08BAAN	8	240
F08BAAP	4	96
G04BAAN	24	480
G06BABN	25	800
G08BAB	20	640
H06BAA	20	480
J06BAA	12	216
J08BAAN	9	288
J10BAAN	8	160
K11BAB	6	240
K12BAB	10	400
K13BABN	12	384

\*Product is shipped in the item box, not in a master shipping carton.

# BOX, CARTON & PALLET QUANTITIES - FASTENERS

## Staples (cont.)

Item Code	Boxes Per Carton	Boxes Per Skid
L06BAB	10	360
L07BABP	N/A*	112
L08BAB	8	288
L10BABN	12	432
L10BHA	12	432
L10HABN	12	432
L11BAB	10	360
L11BGA	10	360
L11BRB	10	360
L11HAB	10	360
L11HBB	10	180
L12BAB	10	360
L12BQB	10	360
L13BABN	8	288
L13BRBN	8	288
L13BRBP	N/A*	36
L13HABN	8	288
L14BAB	6	216
L14BGA	6	216
L14BRB	6	216
L15BAB	6	216
L15BRB	6	216
L17BAB	6	216
M004092	N/A*	180
M06BABN	7	224
M08BAB	6	192
M10BABN	9	288
M10BRBN	9	288
M11BABN	8	256
M11BRBN	8	256
M12BAB	6	192
M13BAB	6	192
M13BRB	6	192
M15BAB	N/A*	60
M17BAB	N/A*	48
N08BABN	6	192
N08BBBN	6	192
N08FBB	6	192
N10BAB	6	192
N11BAB	6	192
N11BRB	6	192
N11FBB	6	192
N12BABN	6	192
N12FABN	5	160
N13BAB	4	128
N13BRB	4	128
N13FAB	4	128
N14BAB	N/A*	56
N14BRB	N/A*	56
N15BAB	N/A*	56
N15BGB	N/A*	165
N15BRB	N/A*	56
N15FAB	N/A*	56
N16BAB	N/A*	56
N16BRB	N/A*	56
N17BAB	N/A*	48
N17BGB	N/A*	165
N17BRB	N/A*	48
N18BAB	N/A*	48
N18BRB	N/A*	48
N19BAB	N/A*	40
N19BGBN	N/A*	130
N19BRB	N/A*	40
N21BAB	N/A*	40
N21BGBN	N/A*	120
N21BRB	N/A*	40
O15BRBBN	N/A*	56
O16BRBBN	N/A*	70
O17BRBBN	N/A*	56
O18BRBBN	N/A*	56
O19BRBBN	N/A*	56

## Staples (cont.)

Item Code	Boxes Per Carton	Boxes Per Skid
P06BAA	N/A*	60
P08BABT	N/A*	60
P10BAB	N/A*	60
P10BPE	N/A*	60
P10FAB	N/A*	60
P11BAB	N/A*	50
P11BPE	N/A*	50
P12BAB	N/A*	40
P13BAB	N/A*	40
P13BGBN	N/A*	60
P13BPE	N/A*	40
P15BAB	N/A*	30
P15BPE	N/A*	30
P17BAB	N/A*	30
P19BAB	N/A*	40
P21BAB	N/A*	40
Q15BAB	N/A*	64
Q17BAB	N/A*	64
Q17BRB	N/A*	64
Q19BAB	N/A*	64
Q19BGBN	N/A*	130
Q19BRB	N/A*	64
Q21BAB	N/A*	56
Q21BRB	N/A*	56
Q23BRB	N/A*	48
Q25BAB	N/A*	48
Q25BRB	N/A*	48
R08BAB	12	384
R10BAB	12	480
R11BAB	12	480
R13BAB	12	480
W10BAB	10	400

## Staples - Specialty

Item Code	Boxes Per Carton	Boxes Per Skid
X04NRA	N/A*	224
X06NRA	N/A*	224
X08NRA	N/A*	224
Y05BFA	10	320
Y07BFA	8	256
Y09BFAN	6	180

## Screws

Item Code	Boxes Per Carton	Boxes Per Skid
06A125P	6	144
06A125PB	N/A*	72
06A162P	6	144
06A162PB	N/A*	72
06A162W	6	144
06B125P	6	144
06B125PB	N/A*	72
06B162P	6	144
06B162PB	N/A*	72
06B200PB	N/A*	48
06C125CB	N/A*	72
06C125PB	N/A*	72
06C125WK	6	240
06C162CB	N/A*	72
06C162PB	N/A*	72
06C162WK	6	240
06C200CB	N/A*	48
06C200PB	N/A*	48
07A200P	6	144

## Screws (cont.)

Item Code	Boxes Per Carton	Boxes Per Skid
07Q100PB	N/A*	72
07Q125PBQ	N/A*	72
08A250PK	6	192
08C300WK	6	144
08D175W	6	144
08D200W	6	144
08D250S	6	144
08D250W	6	144
08D250WK	6	192
08D300W	6	144
08D300WK	6	144
08F150Y	6	144
08F150YTK	6	240
08F175Y	6	144
08F200Y	6	144
08F200YBTHSS	N/A*	48
08F200YTK	6	192
08F250Y	6	144
08F250YK	6	192
08F300Y	6	144
08G100CBWFDS	N/A*	72
08G150CTLDFSS	6	144
08G162CTWFWS	6	144
08G200CKLFPS	6	192
08G200WTWFWS	6	144
08G250WWK	6	192
08L125CBLCTS	N/A*	72
08L175YB	N/A*	72
08M050CTRFDP	6	144
08M050CTRFSP	6	144
08M100CBPDSS	N/A*	72
08R250W	6	144
08R300W	6	144
08S250W003	6	144
08S250W497	6	144
08S250W592	6	144
08T125W	6	144
08T150WBWFDS	N/A*	72
08T200W	6	144
08X125CBACTS	N/A*	72
08X125CKADDS	6	240
08X200CKADDS	6	192
09D300S	6	144
10G125CBWFDS	N/A*	72
10G162CTWFWS	6	144
10M075CDK	6	240
10M075CSK	6	240
10M075CTMFDS	6	144
10M075YKFT4X	6	240
10M075YLFT4X	N/A*	48
10M075YTFDX	6	144
10M100CKMFDS	6	240
12G175YKLFAX	6	240
12G200YKLFAX	6	192
12G250YKLFAX	6	192
12M087YKFF4X	6	240
12M100YKFF3X	6	240

\*Product is shipped in the item box, not in a master shipping carton.

## Tools: DuraSpin (Cordless)

Model	Item #	Page
DS222-18V - 2" Cordless 18v Li-Ion 2500 RPM	10B0001N	3
DS225-18V - 2" Cordless 18v Li-Ion 5000 RPM	10A0001N	3
DS322-18V - 3" Cordless 18v Li-Ion 2500 RPM	10C0001N	3

## Tools: DuraSpin (Corded)

Model	Item #	Page
DS242-AC - 2" Corded 2500 RPM	10E0001N	4
DS245-AC - 2" Corded 5000 RPM	10D0001N	4
DS342-AC - 3" Corded 2500 RPM	10F0001N	4
SG2510 - High-Performance 2500 RPM Screwdriver	6X0002N	7
SG4100 - High-Performance 4000 RPM Screwdriver	6X0004N	7

## Tools: DuraSpin (Attachments)

Model	Item #	Page
DS230-D1 - 2" Auto-Feed Screwdriver Attachment	9Z0011N	5
DS230-D2 - 2" Auto-Feed Screwdriver Attachment	9Z0012N	5
DS230-M1 - 2" Auto-Feed Screwdriver Attachment	9Z0021N	5
DS230-S1 - 2" Auto-Feed Screwdriver Attachment	9Z0001N	5
DS530-D1 - 3" Auto-Feed Screwdriver Attachment	10X0012N	6
DS530-M1 - 3" Auto-Feed Screwdriver Attachment	10X0022N	6
DS530-S1 - 3" Auto-Feed Screwdriver Attachment	10X0002N	6

## Tools: DuraSpin (Attachment Kits)

Model	Item #	Page
DS532-AC - 3" Attachment Kit with 2500 RPM Screwdriver	10X0003N	6
DS534-AC - 3" Auto-Feed Screwdriver Attachment	10X0013N	6

## Tools: Pneumatic

Model	Item #	Page
A11 - 7/16" Crown 3/8" Hammer Stapler	PC0700	50
A20 Hand Nailer - 2" - 7" Bulk Nailer	PC0781	35
BC58 - 1/2" Crown 3/8" Staple + 1" Cap	4A0001N	50
DFXP - 20 GA. 1/2" Crown, 1/2" Staple Clinch Tool	8H0001N	56
F-15XP - 2 1/2" 15 GA. Cordless Pneumatic Finish Nailer	10L0001N	15
F-16XP - 2 1/2" 16 GA. Cordless Pneumatic Finish Nailer	10N0001N	15
F-18XP - 2 1/2" 18 GA. Cordless Pneumatic Brad Nailer	10M0001N	15
F-35FRHXP - Cordless Pneumatic Framing Nailer	10H0001N	31
F-35XP - Cordless Pneumatic Framing Nailer	10G0001N	31
F75LXP - 18 GA. 7/16" Crown, 5/8" Staple Clinch Tool	8J0002N	56
F75SXP - 18 GA. 7/16" Crown, 5/8" Staple Sisal Anvil	8J0001N	56
FinishPro®16XP - 2 1/2" Finish Nailer	9S0001N	18
FinishPro®18BMg - 2 1/2" Brad Nailer	9B0001N	17
FinishPro®18Mg - 2 1/2" Brad Nailer	1U0021N	17
FinishPro®25XP - 2 1/2" Brad Nailer	760102N	18
FinishPro®30XP - 2" Angled Finish Nailer	9P0002N	19
FinishPro®35Mg - 2 1/2" Angled Finish Nailer	6G0001N	19
FinishPro®42XP - 2 1/2" Angled Finish Nailer	4G0001N	19
F-LXP - 1 1/2" 18 GA. 1/4" Crown Cordless Pneumatic Finish Stapler	10Y0001N	15
FN81T1 - 3 1/2" Full Round Head Framing Nailer	FN81T1	32
FN91T1 - 3 1/2" Paper Tape Framing Nailer	FN91T1	32
FramePro®325FRHXP - 3 1/4" Full Round Head Framing Nailer	4H0101N	34
FramePro®325XP - 3 1/4" Paper Tape Framing Nailer	4Z0101N	33
FramePro®701XP - 3 1/2" Paper Tape Framing Nailer	2H0133N	33
FramePro®702XP - 3 1/2" Full Round Head Framing Nailer	2K0103N	34
FramePro®751XP - 3 1/2" Paper Tape Framing Nailer	2J0103N	33
FramePro®752XP - 3 1/2" Full Round Head Framing Nailer	2F0103N	34
JN91H1 - 1 1/2" Metal Connector Nailer	JN91H1	36

## Tools: Pneumatic (cont.)

Model	Item #	Page
JN91H2 - 1 1/2" Metal Connector Nailer	JN91H2	36
JN91P1 - 1 1/2"-2 1/2" Metal Connector Nailer	JN91P1	36
JN91P2 - 1 1/2"-2 1/2" Metal Connector Nailer	JN91P2	36
LS1XP - 1" Headless Brad Nailer	8N0001N	17
Mini Hand Nailer - 2"-3 1/2" Bulk Nailer	PC1195	35
NS20BXP - 7/16" Crown, Heavy Wire Stapler	9Y0001N	38, 62
NS20XP - 7/16" Crown, 2" Heavy Wire Stapler	9X0001N	38
PalletPro™100XP - 4" Coil Nailer (Special Order Tool)	5L0001N	55
PalletPro™130XP - 5 1/8" Coil Nailer (Special Order Tool)	5M0001N	55
PalletPro™57FXP - 2 1/4" Coil Nailer	4L0001N	55
PS15RXP - 1" Crown 1 1/2" Roofing Stapler	9U0001N	50
PS15XP - 1" Wide Crown, 1 1/2" Heavy Wire Stapler	9T0001N	37
PS20XP - 1" Wide Crown, 2" Heavy Wire Stapler	9W0001N	37
RoofPro™445XP - 1 3/4" Coil Nailer	8V0001N	49
SC1XP Senclamp® - 7/16" Crown, 3/8" Senclamp® Fastener	220101N	22
SC2 Sencor® - 1" Crown, 1/2" Corrugated Stapler	470001N	22
SCN60XP - 2 3/4" Coil Nailer	520101N	35
SCN65XP - 3 1/2" Coil Nailer (Flat Safety)	540101N	35
SCN65XP - 3 1/2" Coil Nailer (Toenail Safety)	540104N	35
SCP40XP - 1 1/2" Standard Pressure Pneumatic Concrete & Steel Pinner	7J0001N	37
SFT10XP 20 GA. E Wire - Standard	6S0031N	61
SFT10XP 20 GA. F Wire - Standard	6S0041N	61
SFT10XP 20 GA. G Wire - Standard	6S0051N	61
SFT10XP 22 GA. C Wire - Standard	6S0021N	61
SFT10XP 22 GA. A/D Wire - Auto	6S0101N	61
SFT10XP 22 GA. A/D Wire - Standard	6S0001N	61
SFT10XP 22 GA. B Wire - Standard	6S0011N	61
SFT10XP 22 GA. C Wire - Auto	6S0121N	61
SFT10XP Dbl. Length Mag. 20 GA. F Wire - Auto	6S0341N	61
SFT10XP Dbl. Length Mag. 20 GA. G Wire - Standard	6S0251N	61
SFT10XP Dbl. Length Mag. 20 GA. H Wire - Auto	6S0361N	61
SFT10XP Dbl. Length Mag. 22 GA. B Wire - Auto	6S0311N	61
SFT10XP Dbl. Length Mag. 22 GA. B Wire - Standard	6S0211N	61
SFT10XP Dbl. Length Mag. 22 GA. C Wire - Auto	6S0321N	61
SFT10XP Dbl. Length Mag. 22 GA. C Wire - Standard	6S0221N	61
SFT10XP Long Nose 22 GA. C Wire - Standard	6S0421N	61
SFW09 - 3/8" Crown, 5/8" Fine Wire Stapler	4C0001N	62
SHF200 - 2" Pneumatic Mallet Actuated Flooring Cleat Nailer	8D0001N	67
SKSXP-L Stapler	300120N	20
SKSXP-M Stapler	300152N	20
SKSXP-N Stapler	300184N	20
SLP20XP - 1 1/8" Brad Nailer	430101N	18
SLS150MG - 1/4" Crown, 1 1/8" Medium Wire Stapler	8C0001N	21
SLS18MG - 1/4" Crown, 1 1/2" Medium Wire Stapler	1W0021N	21
SLS20XP-HF - 3/16" Crown, 1" Floor Stapler	490021N	67
SLS20XP-K Stapler	490101N	20
SLS20XP-L Stapler	490103N	20
SLS20XP-L Sencomatic Stapler	490015N	20
SLS20XP-L Stapler With Case	490105N	20
SLS20XP-M Stapler	490107N	20
SLS20XP-R Stapler	490111N	20
SLS25XP-L Stapler	820103N	20
SLS25XP-M Stapler	820107N	20
SN71P1 - 2 1/2" Coil Nailer	SN71P1	49
SNS41 - 7/16" Crown, 2" Heavy Wire Stapler	3L0003N	38
SQS55XP - 7/16" Crown, 2 1/2" Heavy Wire Stapler	660101N	38
TN11G1 - 1 3/8" Headless Pinner	TN11G1	16
TN11L1 - 2" Headless Pinner	TN11L1	16
TN21L1 - 2" Pinner	TN21L1	17

## Tools: Compressors & Kit

Model	Item #	Page
PC0947	PC0947	71
PC0968	PC0968	71
PC1010	PC1010	71
PC1010N	PC1010N	71
PC1131	PC1131	71
PC1280	PC1280	71

# ITEM CODE INDEX

## Fasteners: Nails

Item #	Page
A100509	23
A100629	23
A100759	23
A101009	23
A101259	23
A101379	23
A101509	23
A102009	23
A109809	23
A109909	23
A201009	23
A201259	23
A201509	23
A202009	23
A209809	23
A209909	23
A301500	25
A301750	25
A302000	25
A302009	25
A302500	25
A302509	25
A402009	24
AX10EAA	23
AX11EAA	23
AX13EAA	23
AX15EAA	23
AX17EAA	23
AX18EAA	23
AX19EAA	23
AX21EAA	23
AX22EAA	23
AY10EAA	24
AY11EAA	24
AY13EAA	24
AZ08EAA	24
AZ11EAA	24
AZ13EAA	24
BD17APBC	51
BE23AABF	43, 58
BG17AAAQ	44
BG18AAAQ	44
BK21BPBFN	44, 59
BK23BPBFN	44, 59
BK25BPBFN	44, 59
BL21APBF	43, 58
BT21APBF	42, 43, 58
CZ08EAA	23
CZ10EAA	23
CZ10EAA	23
CZ11EAA	23
CZ11EAA	23
CZ13EAA	23
CZ15EAA	23
CZ16EAA	23
CZ17EAA	23
CZ21EAA	23
DA13EPBN	25
DA15AIA	25
DA15EABN	25
DA15EPBN	25
DA17AIA	25
DA17EABN	25
DA17EPBN	25
DA19AIA	25
DA19EABN	25
DA19EPBN	25
DA21EABN	25
DA21EGBN	25
DA21EPBN	25
DA23EPBN	25
DA25EAB	25

## Fasteners: Nails (cont.)

Item #	Page
DA25EGB	25
DA25EPB	25
ED23AABH	51, 57
EJ21ADBH	51, 57
EJ23ADBH	51
EJ23ASBC	51
EL19AGBH	52, 58
EL19ASBH	52, 58
EL20AABH	52, 58
EL20ASBH	52, 58
EL21AGBH	52, 58
EL21ASBH	52, 58
EL23AABH	52, 58
EL23AGBH	52, 58
EL23ASBC	52
EL23ASBH	52, 58
G524APBXN	39
G524ASBXN	39
G621ASBXN	39
G624APBXN	39
G624ASBXN	39
GC21APBX	40
GC23AHAK	40
GC24APBX	40
GC24ASBX	40
GC25APBX	40
GD21AABF	43, 57
GD21APBF	43, 57
GD24APBSN	41
GD24ASBS	41
GD25AABF	43, 57
GD25AABS	41
GD25APBF	43, 57
GD25APBSN	41
GE21APAX	40
GE21ASBX	40
GE24AGBK	40
GE24APBX	40
GE24ASBX	40
GL21APBF	43, 58
GL21APBSN	42
GL21ASBS	42
GL24AABS	42
GL24AGBF	43, 58
GL24AGBS	42
GL24APBF	43, 58
GL24APBSN	42
GL24ASBF	43, 58
GL24ASBS	42
GT24APBF	42, 58
H527APBXN	39
H528APBXN	39
H627APBXN	39
H627ASBXN	39
HC27APBX	40
HC27ASBX	40
HC28APBX	40
HD27APBF	43, 57
HD27APBSN	41
HE27ASBX	40
HF27EDB	40
HF27EPAK	40
HJ25ADBS	41
HK27APBFN	44, 59
HL27AGBS	42
HL27ASBF	43, 58
HL27ASBS	42
HR22APAF	44
HR74APAF	44
K525APBXN	39
K527APBXN	39
K527APBXR	39

## Fasteners: Nails (cont.)

Item #	Page
K527ASBXN	39
K528APBXN	39
K528APBXR	39
K528ASBXN	39
K529APBXN	39
K627ASBXN	39
K628APBXN	39
K628ASBXN	39
K629ASBXN	39
KC27AGBK	40
KC27APBX	40
KC27ASBX	40
KC28AGBK	40
KC28APBX	40
KC28ASBX	40
KC29APBX	40
KC29ASBX	40
KC31APBX	40
KD25AABS	41
KD25APBF	43, 57
KD25APBSN	41
KD27APBF	43, 57
KD27APBSN	41
KD27ASBF	43, 57
KD27ASBS	41
KD28AGBS	41
KD28APBF	43, 57
KD28APBSN	41
KD28ASBF	43, 57
KD28ASBS	41
KD29APBF	43, 57
KD29APBSN	41
KD29ASBS	41
KJ17AEBD	45
KJ17AHBD	45
KT25APBF	42, 58
LC29APBX	40
M001000	24
M001001	24
M001002	24
M001003	24
M001004	24
M001005	24
M001007	24
M002261	45
M002262	45
M002263	45
M002264	45
M002265	45
M002266	45
M003011	44
M003101	51
M003103	51
M003104	51
M003105	51
M003106	51
MD17AJBDN	45
MD17AQBD	45
MD25AHBD	45
MD25AJBDN	45
MD25AQBDN	45
MD27APBSN	41
MD28APBSN	41
MD34APBF	43, 57
ND25AJBDN	45
ND25AQBDN	45
PI3BGBN	53
RW17BPE	68
RW19BPE	68
RW21BGE	68
RW21BPE	68
SE15APB	52

## Fasteners: Nails (cont.)

Item #	Page
SE15APBH	52, 58
SE17APBH	52, 58
SE19APB	52
W3050YXS	45
W3075YXC	45
W3100YXC	45
W3125YXC	45
W3150YXC	45
ZX10EAA	23
ZX13EAA	23
ZX16EAA	23
ZX18EAA	23
ZX21EAA	23

## Fasteners: Staples

Item #	Page
A04BAAN	63
A06BABN	63
A06BABP	63
A08BAB	63
A08BABP	63
A800629	27
A800759	27
A801009	27
A801259	27
A801509	27
A809909	27
B04BAAPN	63
B06BAAP	63
B08BAAP	63
C02BAAPN	63
C03BAAPN	63
C03BGAN	63
C04BAAP	63
C04BGAN	63
C05BAAPN	63
C06BAAP	63
C06BGA	63
C06BHA	63
C07BAAPN	63
C08BAAP	63
C10BAAP	63
D10BABN	63
D10BABPN	63
E06BAA	64
E08BAA	64
E10BAA	64
F04BAAN	64
F04BAAP	64
F05BAAP	59, 64
F06BAA	59, 64
F06BAAP	59, 64
F06BGA	59, 64
F08BAAN	59, 64
F08BAAP	59, 64
G04BAAN	64
G06BABN	64
G08BAB	64
H06BAA	53, 64
J06BAA	59
J08BAAN	59
J10BAAN	59
K11BAB	26
K12BAB	26
K13BABN	26
L06BAB	27
L07BABP	27
L08BAB	27



### Fasteners: Staples (cont.)

Item #	Page
L10BABN	27
L10BHA	27
L10HABN	27
L11BAB	27
L11BGA	27
L11BRB	27
L11HAB	27
L11HBB	27
L12BAB	27
L12BQB	27
L13BABN	27
L13BRBN	27
L13BRBP	27
L13HABN	27
L14BAB	27
L14BGA	27
L14BRB	27
L15BAB	27
L15BRB	27
L17BAB	27
M06BABN	28
M08BAB	28
M10BABN	28
M10BRBN	28
M11BABN	28
M11BRBN	28
M12BAB	28
M13BAB	28
M13BRB	28
M15BAB	28
M17BAB	28
M004092	53
N08BABN	28, 47, 65
N08BBBN	28, 47, 65
N08FBB	28, 47, 65
N10BAB	28, 47, 65
N11BAB	28, 47, 65
N11BRB	28, 47, 65
N11FBB	28, 47, 65
N12BABN	28, 47, 65
N12FABN	28, 47, 65
N13BAB	28, 47, 65
N13BRB	28, 47, 65
N13FAB	28, 47, 65
N14BAB	28, 47, 65
N14BRB	28, 47, 65
N15BAB	28, 47, 65
N15BGB	28, 47, 65
N15BRB	28, 47, 65
N15FAB	28, 47, 65
N16BAB	28, 47, 65
N16BRB	28, 47, 65
N17BAB	28, 47, 65
N17BGB	28, 47, 65
N17BRB	28, 47, 65
N18BAB	28, 47, 65
N18BRB	28, 47, 65
N19BAB	28, 47, 65
N19BGBN	28, 47, 65
N19BRB	28, 47, 65
N21BAB	28, 47, 65
N21BGBN	28, 47, 65
N21BRB	28, 47, 65
O15BRBBN	46, 65
O16BRBBN	46, 65
O17BRBBN	46, 65
O18BRBBN	46, 65
O19BRBBN	46, 65
P06BAA	46, 53
P08BAPT	46, 53
P10BAB	46, 53
P10BPE	46, 53

### Fasteners: Staples (cont.)

Item #	Page
P10FAB	46, 53
P11BAB	46, 53
P11BPE	46, 53
P12BAB	46, 53
P13BAB	46, 53
P13BGBN	46
P13BPE	46, 53
P15BAB	46, 53
P15BPE	46, 53
P17BAB	46, 53
P19BAB	46
P21BAB	46
Q15BAB	47
Q17BAB	47
Q17BRB	47
Q19BAB	47
Q19BGBN	47
Q19BRB	47
Q21BAB	47
Q21BRB	47
Q23BRB	47
Q25BAB	47
Q25BRB	47
R08BAB	26
R10BAB	26, 68
R11BAB	26, 68
R13BAB	26, 68
W10BAB	63

### Fasteners: Staples — Specialty

Item #	Page
X04NRA	29
X06NRA	29
X08NRA	29
Y05BFA	29
Y07BFA	29
Y09BFAN	29

### Fasteners: Screws

Item #	Page
06A125P	8
06A125PB	8
06A162P	8
06A162PB	8
06A162W	8
06B125P	8
06B125PB	8
06B162P	8
06B162PB	8
06B200PB	8
06C125CB	8
06C125PB	8
06C125WK	8
06C162CB	8
06C162PB	8
06C162WK	8
06C200CB	8
06C200PB	8
07A200P	8
07Q100PB	9
07Q125PBQ	9
08A250PK	9
08C300WK	8
08D175W	8

### Fasteners: Screws (cont.)

Item #	Page
08D200W	9
08D250S	9
08D250W	9
08D250WK	9
08D300W	9
08D300WK	9
08F150Y	8
08F150YTK	8
08F175Y	8
08F175YTK	8
08F200Y	8
08F200YBTHSS	8
08F200YTK	8
08F250Y	8
08F250YK	8
08F300Y	8
08G100CBWFDS	9
08G150CTLDSS	9
08G162CTWFWS	9
08G200CKLFPS	9
08G200TWFWS	9
08G250WWK	9
08L125CBLCTS	8
08L175YB	8
08M050CTRFDP	11
08M050CTRFSP	11
08M100CBPDSS	11
08R250W	10
08R300W	10
08S250W003	10
08S250W497	10
08S250W592	10
08T125W	9
08T150WBWFDS	9
08T200W	9
08X125CBACTS	11
08X125CKADDS	11
08X200CKADDS	11
09D300S	9
10G125CBWFDS	9
10G162CTWFWS	9
10M075CDK	11
10M075CSK	11
10M075CTMFDS	10
10M075YKFT4X	10
10M075YLFT4X	10
10M075YTFDX	10
10M100CKMFDS	10
12G175YKLFAX	9
12G200YKLFAX	9
12G250YKLFAX	9
12M087YKFF4X	10
12M100YKFF3X	10

### Accessories: Screw System

Item #	Page
6W0003N	6
920001N	5
920011N	5
920012N	5
920021N	5
ADP009	12
ADP019	12
EA0272	12
EA0297	12
EA0297N	12
EA0298	12
EA0298N	12

### Accessories: Screw System (cont.)

Item #	Page
EA0299	12
EA0299N	12
EA0300	12
EA0301	12
EA0301N	12
EA0302	12
EA0308	12
EA0313N	12
EA0314	12
EA0315	12
EA0315N	12
EA0316	12
EA0316N	12
EA0320	12
EA0321	12
EA0322	12
EA0396	12
EA0397	12
EA0400	12
EA0401	12
EA0402	12
FA0334	13
FB0155	13
FB0157	13
FB0159	13
FC0822	13
FC0878	13
FC0887	13
FC0895	13
FC0983	13
FC1022	13
FC1023	13
MB0173	12
MB0174	12

### Accessories: Pneumatic

Item #	Page
HA0308	51
HC0788	38, 62
MA0013	51
NP003	37
PC0051	75
PC0057	75
PC0064	73
PC0065	73
PC0101	76
PC0102	76
PC0103	76
PC0344	76
PC0349	75
PC0350	76
PC0351	76
PC0477	74
PC0478	74
PC0479	74
PC0480	74
PC0489	75
PC0501	74
PC0502	74
PC0503	74
PC0504	74
PC0505	74
PC0506	74
PC0576	74
PC0577	74
PC0629	76
PC0630	76

## Accessories: Pneumatic (cont.)

Item #	Page
PC0643	75
PC0656	75
PC0657	75
PC0900	74
PC0977	73
PC0978	73
PC0979	73
PC0983	75
PC0987	75
PCI138	75
PCI152	73
PCI166	76
PCI295	76
PCI319	73
PCI320	73
PCI321	73
PCI322	73
PCI323	74
PCI325	74
PCI328	74
PCI330	74
PCI337	73
PCI338	73
PCI339	73
PCI340	73
PCI341	73
SWM125B	37
YB0123	76
YJ0042	33
YJ0043	33
YJ0044	37
YJ0055	33

## Accessories: Battery & Charger Systems

Item #	Page
VB0155	13, 31, 77
VB0156	13, 31, 77
VB0189	13, 77
VB0190	13, 77

## Accessories: No-Mar Pads

Item #	Page
HA0170	77
HA0200	77
HA0201	77
HC0253	77
HC0396	77
HC0401	77
HC0463	77
HC0506	77
HC0507	77
HC0536	77
HC0571	77
HC0572	77
HC0625	77
HC0626	77
HC0729	77
HF0028	77
HF0029	77
HF0046	77
HF0064	77
HF0079	77
HF0110	77
HF0113	77





## FINISH & WOODWORKING

15 GA	16 GA	18 GA	21 GA		
					
Pg. 25	Pg. 24	Pg. 23-24	Pg. 23		
23 GA	19 GA	18 GA	16 GA	SENCLAMP	SENCLAMP
					
Pg. 23	Pg. 26	Pg. 27-28	Pg. 28	Pg. 29	Pg. 29

## FRAMING, SHEATHING & SUBFLOORS

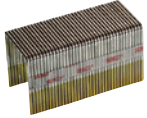
34° Prohead	34°	20°	COIL	METAL	CONCRETE	15 GA	16 GA	17 GA
								
Pg. 39	Pg. 40	Pg. 41-42	Pg. 42-44	Pg. 45	Pg. 45	Pg. 47	Pg. 46-47	Pg. 46

## ROOFING, SIDING & FENCING

ROOFING	16 GA WIDE CROWN	FELT CAP & STAPLE	20 GA	WIRE WELD	PLASTIC WOUND
					
Pg. 51-52	Pg. 53	Pg. 53	Pg. 53	Pg. 51-52	Pg. 51-52

## FLOORING

CLEAT	19 GA
	
Pg. 68	Pg. 68







## PALLETS & CRATING

15° SMOOTH	15° RING	15° SCREW	20 GA	18 GA
				
Pg. 57	Pg. 58	Pg. 59	Pg. 59	Pg. 59

## UPHOLSTERY & FURNITURE

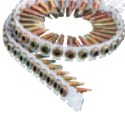

22 GA	21 GA	20 GA	17 GA	16 GA
				
Pg. 63	Pg. 63	Pg. 64	Pg. 65	Pg. 65

# DURASPIN AUTO-FEED SCREW SYSTEMS





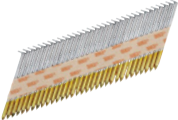
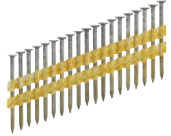

DRYWALL	WOOD/WOOD	WOOD/STEEL	UNDERLAYMENT	DECKS & DOCKS	METAL/METAL	LOW PROFILE FRAMING	SPECIALTY
							
Pg. 8	Pg. 8	Pg. 9	Pg. 9	Pg. 9-10	Pg. 10	Pg. 11	Pg. 11

REFERENCE

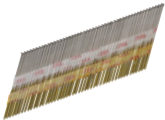

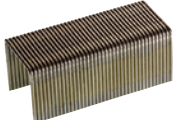
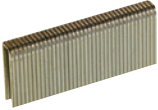
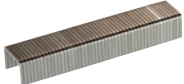





## HOT DIPPED GALVANIZED

34°	20°	15° COIL
		
Pg. 39, 40 & 45	Pg. 41-42	Pg. 43, 51, 52, 57, 58

## 304 STAINLESS STEEL

15 GA	34°	20°	15° COIL	15 GA	
					
Pg. 25	Pg. 40	Pg. 41-42	Pg. 43, 52, 58	Pg. 47	
16 GA	18 GA	20 GA	22 GA	#2 FLAT HEAD	CLEAT
					
Pg. 46, 47, 53, 65	Pg. 27	Pg. 64	Pg. 63	Pg. 9	Pg. 68

## DURASPIN AUTO-FEED SCREW SYSTEMS

<b>DS225-18V</b> 10A0001N	<b>DS222-18V</b> 10B0001N	<b>DS322-18V</b> 10C0001N	<b>DS245-AC</b> 10D0001N	<b>DS242-AC</b> 10E0001N	<b>DS342-AC</b> 10F0001N
					
Pg. 3	Pg. 3	Pg. 3	Pg. 4	Pg. 4	Pg. 4
<b>DS230-S1</b> 9Z0001N	<b>DS230-M1</b> 9Z0021N	<b>DS230-D1</b> 9Z0011N	<b>DS230-D2</b> 9Z0012N		
					
Pg. 5	Pg. 5	Pg. 5	Pg. 5		
<b>DS530 SERIES</b> 10X0002N   10X0012N   10X0022N		<b>DS532-AC</b> 10X0003N	<b>DS534-AC</b> 10X0013N		
					
Pg. 6		Pg. 6	Pg. 6		
<b>SG2510</b> 6X0002N	<b>SG4100</b> 6X0004N				
					
Pg. 7	Pg. 7				

Fasteners: see pages 8 - 11



## FINISH & WOODWORKING

F-18XP	F-16XP	F-15	F-LXP	TN11G1	TN11L1	TN21L1	LS1XP	FinishPro18Mg
10M0001N	10N00001N	10L00001N	10Y00001N	TN11G1	TN11L1	TN21L1	8N0001N	1U0021N
								
Pg. 15	Pg. 15	Pg. 15	Pg. 15	Pg. 16	Pg. 16	Pg. 17	Pg. 17	Pg. 17
FinishPro18BMg	SLP20XP	FinishPro25XP	FinishPro16XP	FinishPro30XP	FinishPro35Mg	FinishPro42XP		
9B0001N	430101N	760102N	9S0001N	9P0002N	6G0001N	4G0001N		
								
Pg. 17	Pg. 18	Pg. 18	Pg. 18	Pg. 19	Pg. 19	Pg. 19		
SLS20XP	SLS25XP	SKSXP	SLS150Mg	SLS18Mg	SC1XP	SC2		
SEE SPECIFICATIONS	SEE SPECIFICATIONS	SEE SPECIFICATIONS	8C0001N	1W0021N	220101N	470001N		
								
Pg. 20	Pg. 20	Pg. 20	Pg. 21	Pg. 21	Pg. 22	Pg. 22		

Fasteners: see pages 23-29

## FRAMING, SHEATHING & SUBFLOORS

F-35XP	F-35FRHXP	FN91T	FN81T1	FramePro325XP	FramePro701XP	FramePro751XP	FramePro325FRHXP	FramePro702XP
10G0001N	10H0001N	FN91T	FN81T1	4Z0101N	2H0133N	2J0103N	4H0101N	#2K0103N
								
Pg. 31	Pg. 31	Pg. 32	Pg. 32	Pg. 33	Pg. 33	Pg. 33	Pg. 34	Pg. 34
FramePro752XP	SCN60XP	SCN65XP	Mini Hand Nailer	A20 Hand Nailer	JN91H1	JN91H2	JN91P1	JN91P2
2F0103N	520101N	540101N/540104N	PC1195	PC0781	JN91H1	JN91H2	JN91P1	#JN91P2
								
Pg. 34	Pg. 35	Pg. 35	Pg. 35	Pg. 35	Pg. 36	Pg. 36	Pg. 36	Pg. 36

Fasteners: see pages 39-45

SCP40XP	PS15XP	PS20XP	NS20XP	NS20BXP	SNS41	SQS55XP
7J0001N	9T0001N	9W0001N	9X0001N	9Y0001N	3L0003N	660101N
						
Pg. 37	Pg. 37	Pg. 37	Pg. 38	Pg. 38	Pg. 38	Pg. 38

Fasteners: see pages 45-47

## ROOFING, SIDING & FENCING

RoofPro445XP	SN71P1	PS15RXP	BC58 Cap	A11 Hammer Stapler
8V0001N	SN71P1	9U0001N	4A0001N	PC0700
				
Pg. 49	Pg. 49	Pg. 50	Pg. 50	Pg. 50

Fasteners: see pages 51-53

## PALLETS & CRATING

PalletPro57FXP	PalletPro100XP	PalletPro130XP	DFXP	F75LXP	F75SXP
4L0001N	5L0001N	5M0001N	8H0001N	8J0002N	8J0001N
					
Pg. 55	Pg. 55	Pg. 55	Pg. 56	Pg. 56	Pg. 56

Fasteners: see pages 57-59

## UPHOLSTERY & FURNITURE

SFT10XP, SFT10XP Double Length Magazine, SFT10XP Long Nose	SFW09	NS20BXP
SEE SPECIFICATIONS	4C0001N	9Y0001N
		
Pg. 61	Pg. 62	Pg. 62

Fasteners: see pages 63-65

## FLOORING

SHF200	SLS20XP-HF
8D0001N	490021N
	
Pg. 67	Pg. 67

Fasteners: see page 68



## AIR COMPRESSORS & KIT

PC1131	PC0968	PC1280	PC1010	PC1010N	PC0947
					
Pg. 71	Pg. 71	Pg. 71	Pg. 71	Pg. 71	Pg. 71

F-15XP | F-16XP | F-18XP | F-LXP

# RETHINK **CORDLESS**



## **FUSION CORDLESS AIR-POWER TECHNOLOGY**

True pneumatic performance with no ramp-up time and the power to drive into the hardest substrates, including solid oak

## **TOOL-FREE DEPTH-OF-DRIVE**

Quickly adjust the depth for consistent flush or countersunk drives

## **ALUMINUM DRIVE CYLINDER**

Reduces weight and provides superior durability

## **NARROW NOSE DESIGN**

Improves line of sight, includes no mar pad to protect woodwork

## **BATTERY STATUS LIGHTS**

Quickly indicates battery power level

## **SELECTABLE ACTUATION SWITCH**

Easily and safely change from sequential to bump fire modes

**FUSION**<sup>™</sup>  
TECHNOLOGY

## KYOCERA SENCO Industrial Tools, Inc.

### Looking for more?



#### Contact Us

8450 Broadwell Road  
Cincinnati, Ohio 45244

Phone: 800.543.4596  
Fax: 800.543.3299



#### Visit Us

On the web for more information  
[SENCO.com](http://SENCO.com)



#### Find Us

Search for your closest SENCO dealer  
[SENCO.com/dealer-locator](http://SENCO.com/dealer-locator)



#### Join Us

Join our loyalty & rewards program  
[SENCOPROteam.com](http://SENCOPROteam.com)



#### Watch Us

Check out all of our latest videos & product launches  
[▶ Youtube.com/SencoBrands](https://www.youtube.com/SencoBrands)



#### Follow Us

On Twitter & Facebook for the latest SENCO news  
[f](#) [t](#) @SENCOBrands

# SENCO<sup>®</sup>

MAKING HARD WORK EASIER